

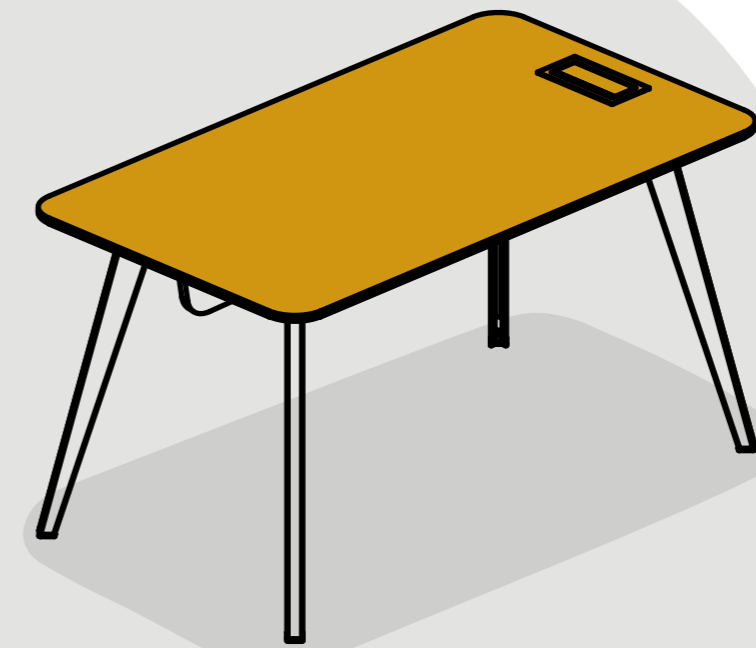

better office mood

# Desk

WORKING  
SPACES

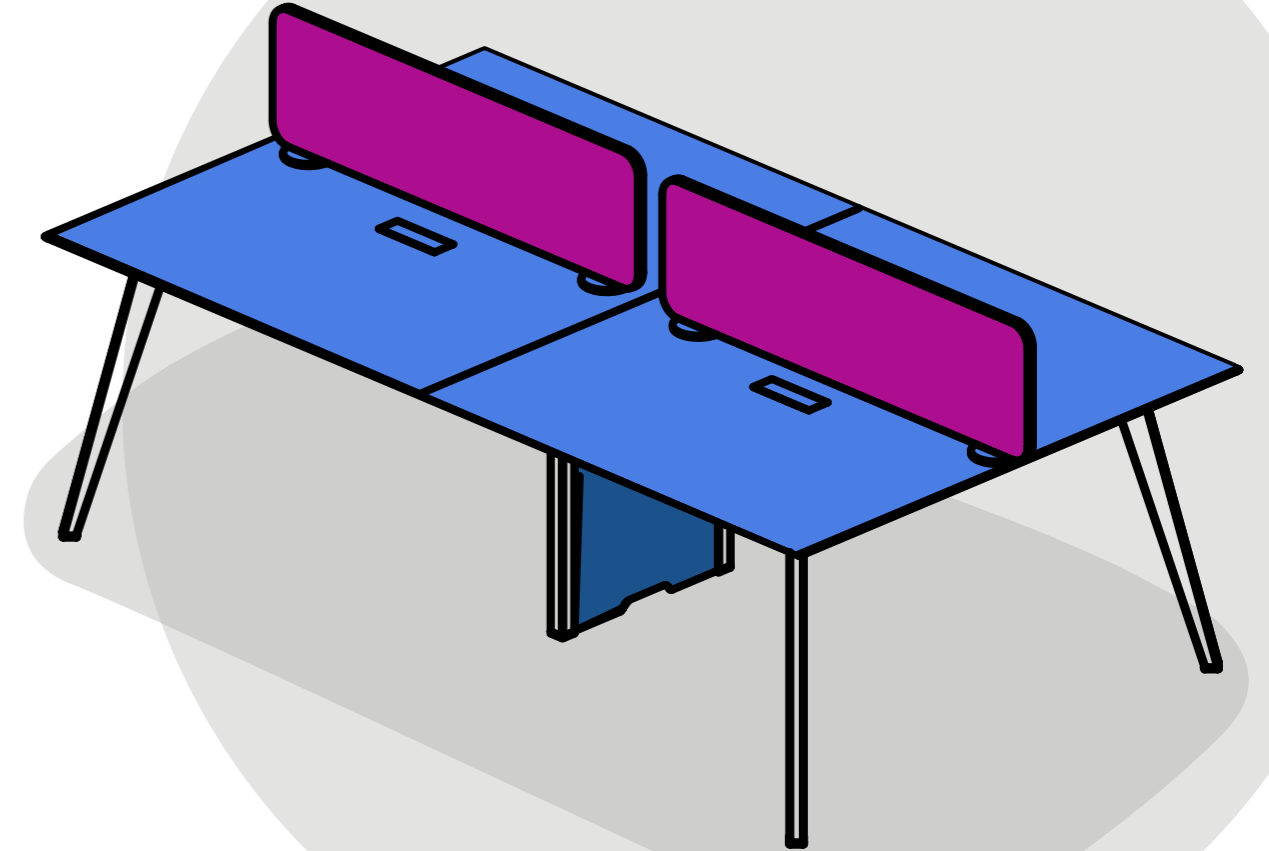

#workspaces2024

# Sail



01

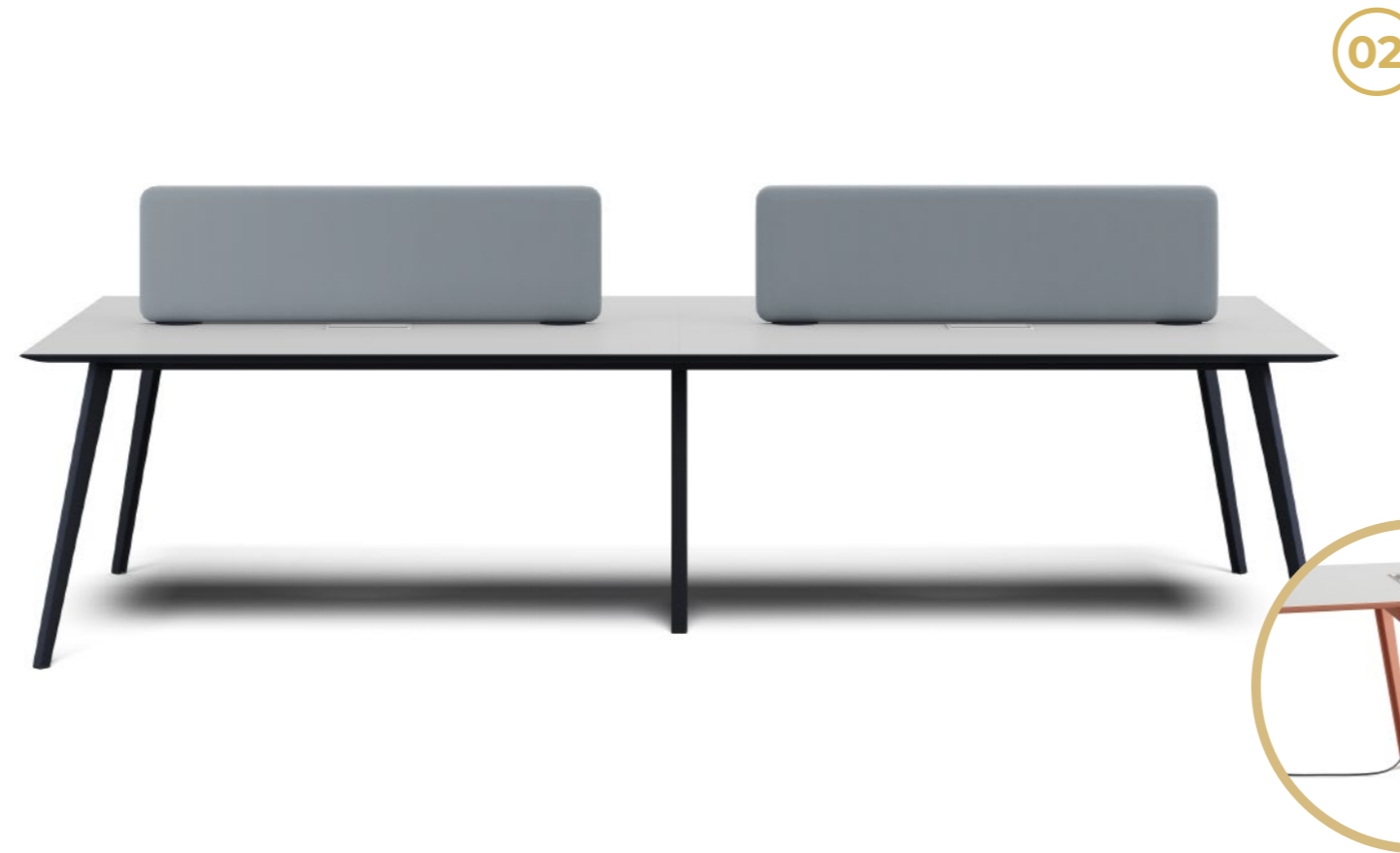

02



03

**WORKING  
SPACES**

01  
Sail Manager Desk

02  
Sail Workstation 4P

03  
Sail Workstation 2P

  
#workingspaces2024

# Sail

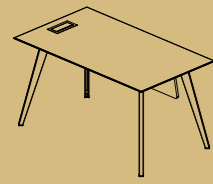

## Single Desk

Width 120/140/160/180  
Depth 70/80  
Height 75

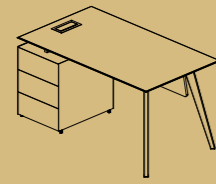

## Single Desk 45

Width 142/162/182/202  
Depth 70/80  
Height 75

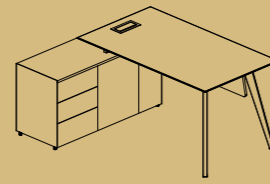

## Single Desk 115

Width 142/162/182/202  
Depth 126  
Height 75

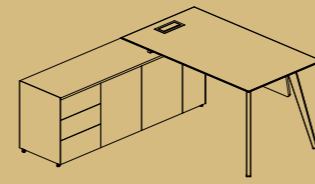

## Single Desk 160

Width 142/162/182/202  
Depth 171  
Height 75

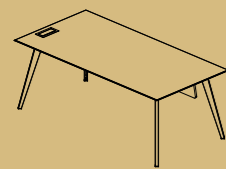

## Manager

Width 200  
Depth 100  
Height 75

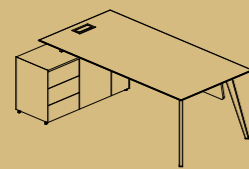

## Manager 115

Width 222  
Depth 126  
Height 75

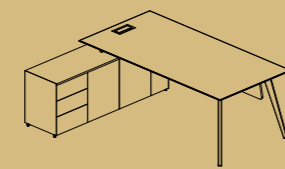

## Manager 160

Width 222  
Depth 171  
Height 75

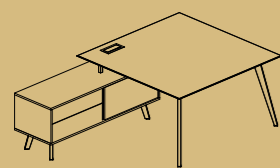

## Manager Desk

Width 145/165  
Depth 220/230  
Height 75

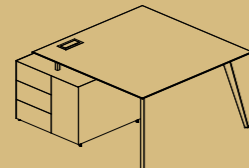

## Manager T 80

Width 140/160  
Depth 180/200  
Height 75  
Table Top Width 140/140  
Table Top Depth 160/160

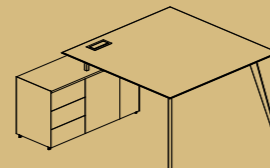

## Manager T 115

Width 185/195  
Depth 162/182  
Height 75  
Table Top Width 140/140  
Table Top Depth 160/160

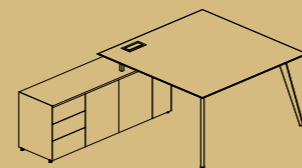

## Manager T 160

Width 230/240  
Depth 162/182  
Height 75  
Table Top Width 140/140  
Table Top Depth 160/160

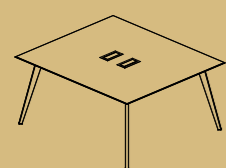

## 2P Workstation

Width 120/140/160/180  
Depth 140/160  
Height 75

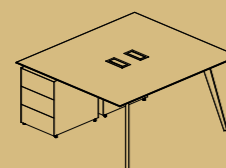

## 2P Workstation 45

Width 142/162/182/202  
Depth 140/160  
Height 75

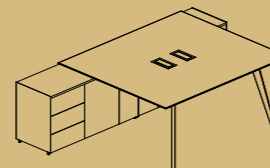

## 2P Workstation 115

Width 142/162/182/202  
Depth 230  
Height 75

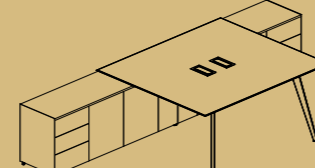

## 2P Workstation 160

Width 142/162/182/202  
Depth 230/320  
Height 75

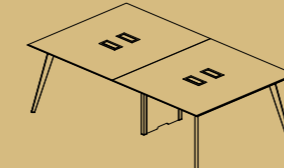

## 4P Workstation

Width 240/280/320/360  
Depth 140/160  
Height 75

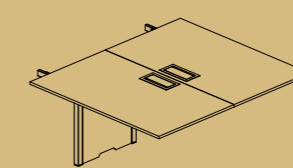

## Workstation Extention

Width 120/140/160/180  
Depth 140/160  
Height 75



#workingspaces2024

# Geo

## WORKING SPACES

01



02



03



01  
Geo Workstation 4P

02  
Geo Manager Desk

03  
Geo Manager Desk



#workingspaces2024

# Geo

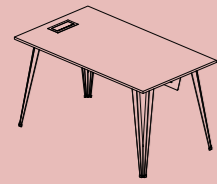

## Single Desk

Width 120/140/160/180  
Depth 70/80  
Height 75

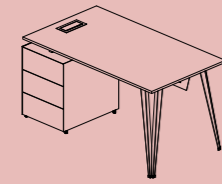

## Single Desk 45

Width 142/162/182/202  
Depth 70/80  
Height 75

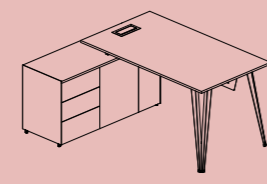

## Single Desk 115

Width 142/162/182/202  
Depth 126  
Height 75

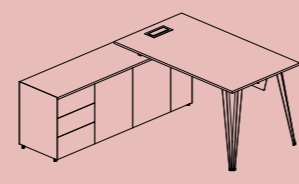

## Single Desk 160

Width 142/162/182/202  
Depth 171  
Height 75

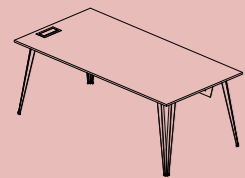

## Manager

Width 200  
Depth 100  
Height 75

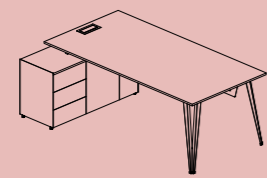

## Manager 115

Width 222  
Depth 126  
Height 75

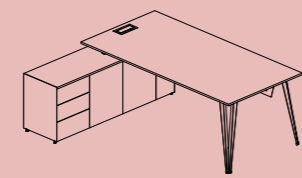

## Manager 160

Width 222  
Depth 171  
Height 75

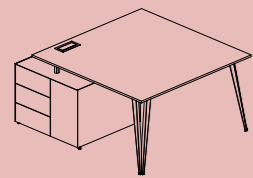

## Manager T 80

Width 140/160  
Depth 180/200  
Height 75  
Table Top Width 140/140  
Table Top Depth 160/160

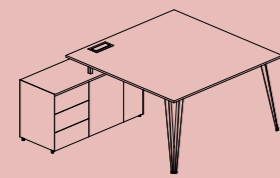

## Manager T 115

Width 185/195  
Depth 162/182  
Height 75  
Table Top Width 140/140  
Table Top Depth 160/160

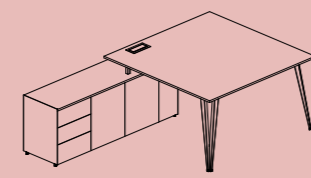

## Manager T 160

Width 230/240  
Depth 162/182  
Height 75  
Table Top Width 140/160  
Table Top Depth 140/160

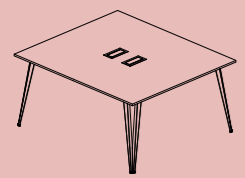

## 2P Workstation

Width 120/140/160/180  
Depth 140/160  
Height 75

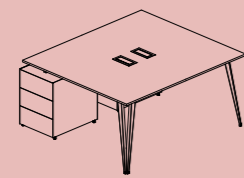

## 2P Workstation 45

Width 142/162/182/202  
Depth 140/160  
Height 75

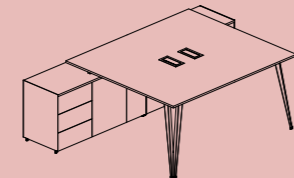

## 2P Workstation 115

Width 142/162/182/202  
Depth 230  
Height 75

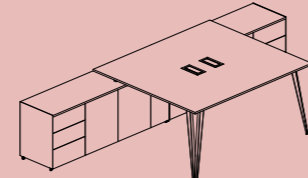

## 2P Workstation 160

Width 142/162/182/202  
Depth 230/320  
Height 75

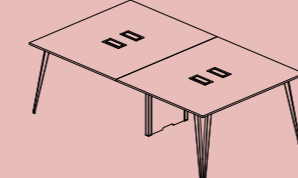

## 4P Workstation

Width 240/280/320/360  
Depth 140/160  
Height 75

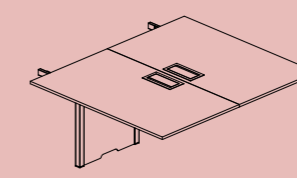

## Workstation Extension

Width 120/140/160/180  
Depth 140/160  
Height 75

# Planet

WORKING SPACES



Space Styled,  
Work Perfected.

01  
Planet Manager Desk

02  
Planet Workstation 2P

03  
Planet Manager Desk



#workingspaces2024

# Planet

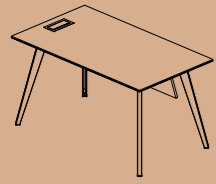

## Single Desk

Width 120/140/160/180  
Depth 70/80  
Height 75

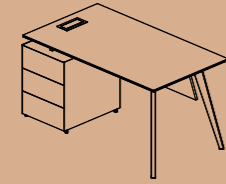

## Single Desk 45

Width 142/162/182/202  
Depth 70/80  
Height 75

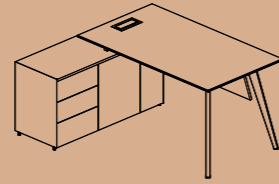

## Single Desk 115

Width 142/162/182/202  
Depth 70/80  
Height 75

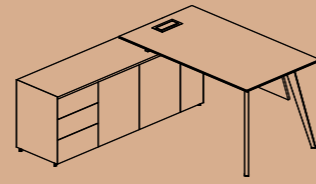

## Single Desk 160

Width 142/162/182/202  
Depth 126  
Height 75

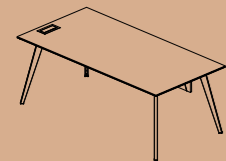

## Manager

Width 200  
Depth 100  
Height 75

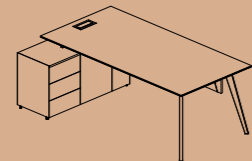

## Manager 115

Width 222  
Depth 126  
Height 75

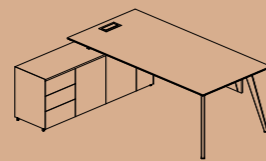

## Manager 160

Width 222  
Depth 171  
Height 75

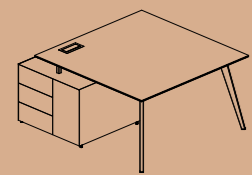

## Manager T 80

Width 150/170  
Depth 162/182  
Height 75  
Table Top Width 140/140  
Table Top Depth 160/160

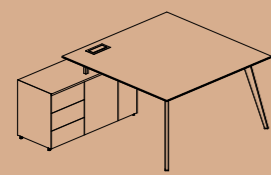

## Manager T 115

Width 185/195  
Depth 162/182  
Height 75  
Table Top Width 140/140  
Table Top Depth 160/160

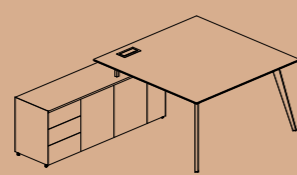

## Manager T 160

Width 230/240  
Depth 162/182  
Height 75  
Table Top Width 140/140  
Table Top Depth 160/160

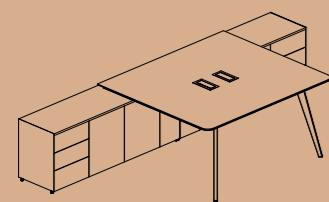

## 2P Workstation 160

Width 142/162/182/202  
Depth 230/320  
Height 75

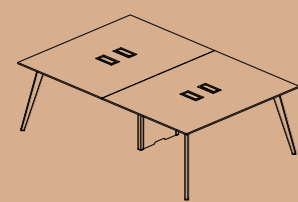

## 4P Workstation R

Width 240/280/320/360  
Depth 140/160  
Height 75

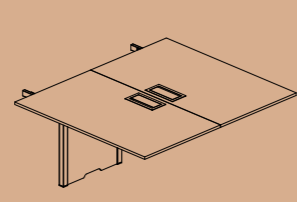

## Workstation Extension

Width 120/140/160/180  
Depth 140/160  
Height 75

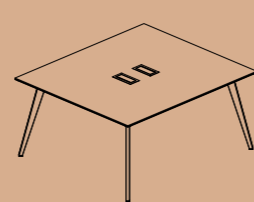

## 2P Workstation

Width 120/140/160/180  
Depth 140/160  
Height 75

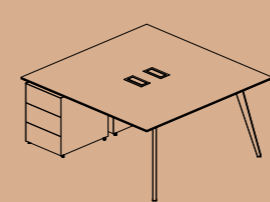

## 2P Workstation 45

Width 142/162/182/202  
Depth 140/160  
Height 75

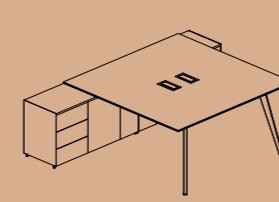

## 2P Workstation 115

Width 142/162/182/202  
Depth 230  
Height 75

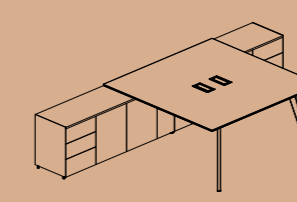

## 2P Workstation 160

Width 142/162/182/202  
Depth 230/320  
Height 75

# WORKING SPACES

01



# PlanetR

01  
PlanetR Desk



#workingspaces2024

# PlanetR

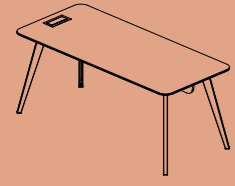

## Single Desk

Width 120/140/160/180  
Depth 70/80  
Height 75

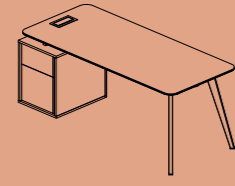

## Single Desk 45

Width 142/162/182/202  
Depth 70/80  
Height 75

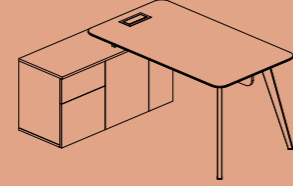

## Single Desk 115

Width 142/162/182/202  
Depth 126  
Height 75

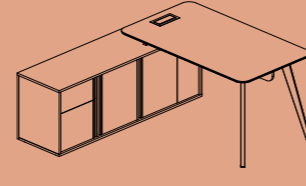

## Single Desk 160

Width 142/162/182/202  
Depth 171  
Height 75

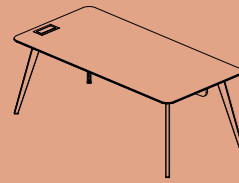

## Manager

Width 200  
Depth 100  
Height 75

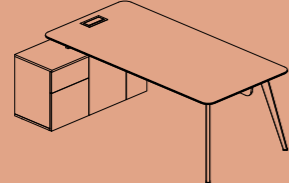

## Manager 115

Width 222  
Depth 126  
Height 75

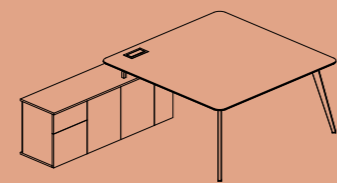

## Manager 160

Width 222  
Depth 171  
Height 75

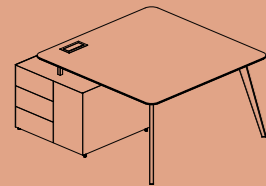

## Manager T 80

Width 140/170  
Depth 180/200  
Height 75  
Table Top Width 140/140  
Table Top Depth 160/160

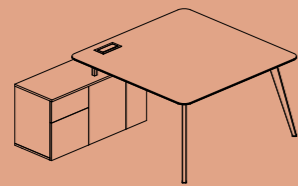

## Manager T 115

Width 185/195  
Depth 162/182  
Height 75  
Table Top Width 140/140  
Table Top Depth 160/160

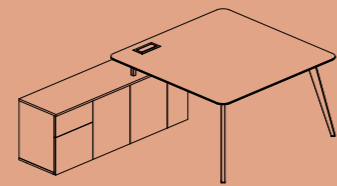

## Manager T 160

Width 230/240  
Depth 162/182  
Height 75  
Table Top Width 140/160  
Table Top Depth 140/160

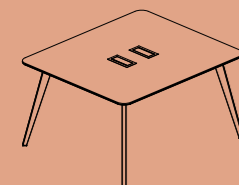

## 2P Workstation

Width 120/140/160/180  
Depth 140/160  
Height 75

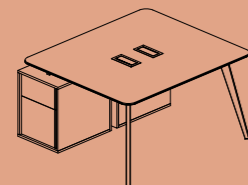

## 2P Workstation 45

Width 142/162/182/202  
Depth 140/160  
Height 75

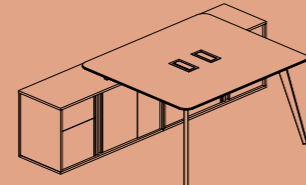

## 2P Workstation 115

Width 142/162/182/202  
Depth 230  
Height 75

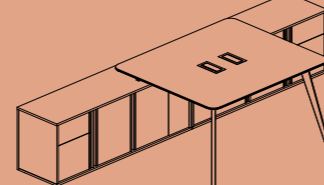

## 2P Workstation 160

Width 142/162/182/202  
Depth 230/320  
Height 75

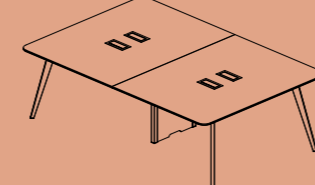

## 4P Workstation

Width 240/280/320/360  
Depth 140/160  
Height 75

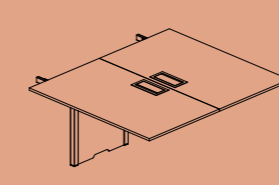

## Workstation Extension

Width 120/140/160/180  
Depth 140/160  
Height 75

# Slide

## WORKING SPACES



01

01  
Slide Workstation 2P



02

02  
Slide Workstation 4P

Space Styled, Work Perfected.

  
#workingspaces2024

# Slide

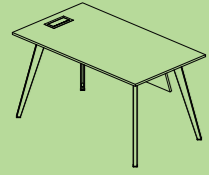

## Single Desk

Width 120/140/160/180  
Depth 70/80  
Height 75

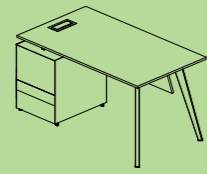

## Single Desk 45

Width 142/162/182/202  
Depth 70/80  
Height 75

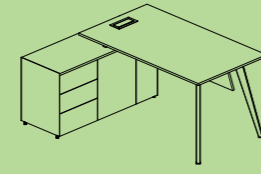

## Single Desk 115

Width 142/162/182/202  
Depth 126  
Height 75

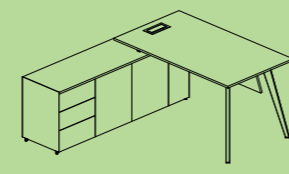

## Single Desk 160

Width 142/162/182/202  
Depth 171  
Height 75

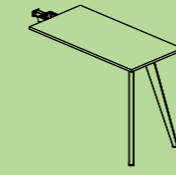

## Single Desk Extension

Width 100  
Depth 50  
Height 75

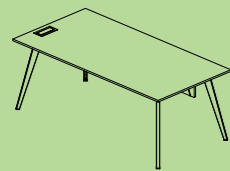

## Manager

Width 200  
Depth 100  
Height 75

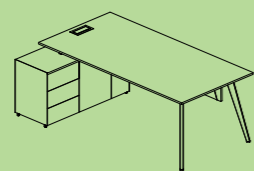

## Manager 115

Width 222  
Depth 126  
Height 75

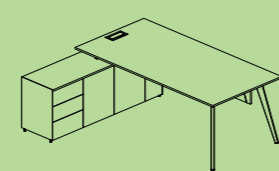

## Manager 160

Width 222  
Depth 171  
Height 75

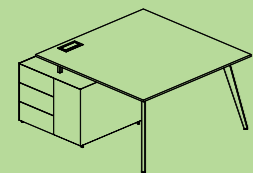

## Manager T80

Width 140/160  
Depth 180/200  
Height 75  
Table Top Width 140/140  
Table Top Depth 160/160

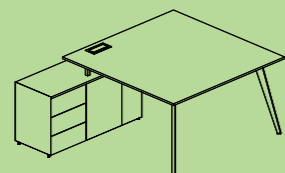

## Manager T 115

Width 185/195  
Depth 162/182  
Height 75  
Table Top Width 140/160  
Table Top Depth 140/160

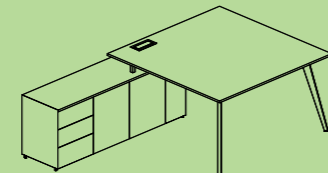

## Manager T 160

Width 230/240  
Depth 162/182  
Height 75  
Table Top Width 140/160  
Table Top Depth 140/160

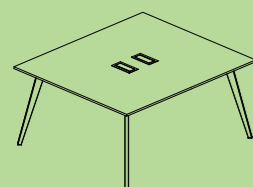

## 2P Workstation

Width 120/140/160/180  
Depth 140/160  
Height 75

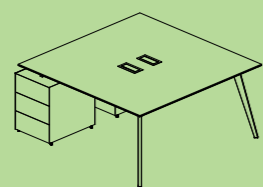

## 2P Workstation 45

Width 142/162/182/202  
Depth 140/160  
Height 75

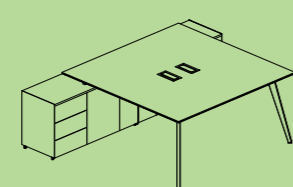

## 2P Workstation 115

Width 142/162/182/202  
Depth 230/320  
Height 75

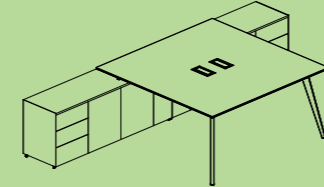

## 2P Workstation 160

Width 142/162/182/202  
Depth 320  
Height 75

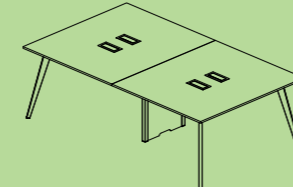

## 4P Workstation

Width 240/280/320/360  
Depth 140/160  
Height 75

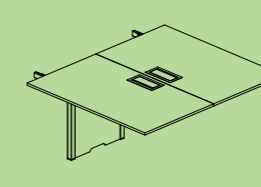

## Workstation Extension

Width 120/140/160/180  
Depth 140/160  
Height 75

# WORKING SPACES

01



02



03



# Polo

01  
Polo Workstation 2P

02  
Polo Manager Desk

03  
Polo Workstation 4P



#workingspaces2024

# Polo

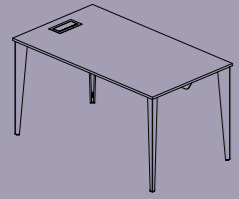

## Single Desk

Width 120/140/160/180  
Depth 70/80  
Height 75

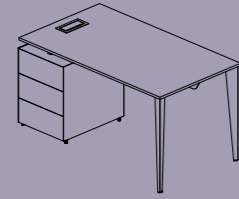

## Single Desk 45

Width 142/162/182/202  
Depth 70/80  
Height 75

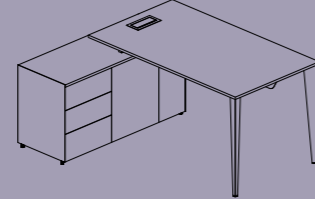

## Single Desk 115

Width 142/162/182/202  
Depth 126  
Height 75

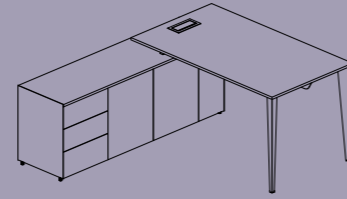

## Single Desk 160

Width 142/162/182/202  
Depth 171  
Height 75

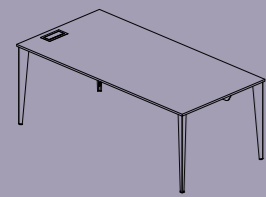

## Manager

Width 200  
Depth 100  
Height 75

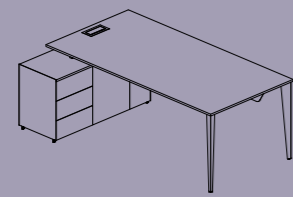

## Manager 115

Width 222  
Depth 126  
Height 75

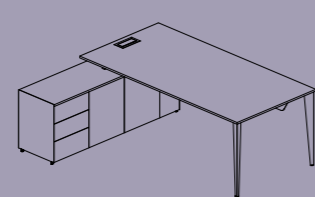

## Manager 160

Width 222  
Depth 171  
Height 75

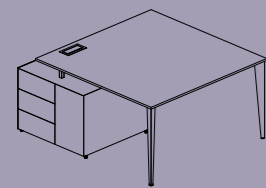

## Manager T 80

Width 140/160  
Depth 180/200  
Height 75  
Table Top Width 140/160  
Table Top Depth 140/160

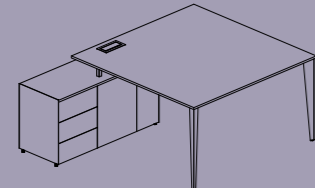

## Manager T 115

Width 185/195  
Depth 162/182  
Height 75  
Table Top Width 140/160  
Table Top Depth 140/160

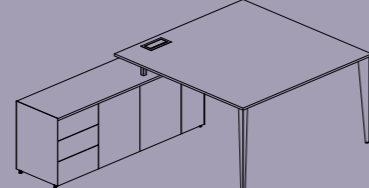

## Manager T 160

Width 230/240  
Depth 162/182  
Height 75  
Table Top Width 140/160  
Table Top Depth 140/160

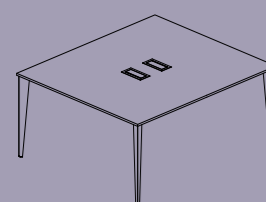

## 2P Workstation

Width 120/140/160/180  
Depth 140/160  
Height 75

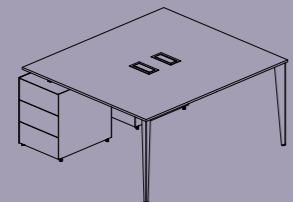

## 2P Workstation 45

Width 142/162/182/202  
Depth 140/160  
Height 75

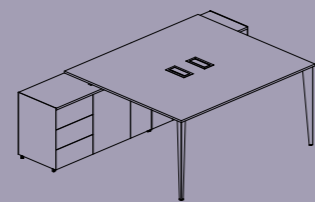

## 2P Workstation 115

Width 142/162/182/202  
Depth 230  
Height 75

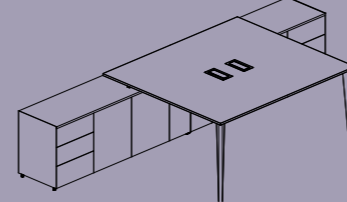

## 2P Workstation 160

Width 142/162/182/202  
Depth 230/320  
Height 75

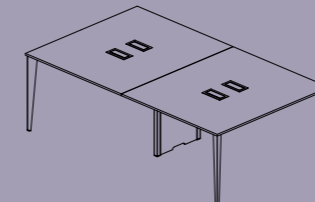

## 4P Workstation

Width 240/280/320/360  
Depth 140/160  
Height 75

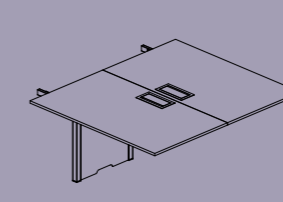

## Workstation Extension

Width 120/140/160/180  
Depth 140/160  
Height 75

# Steel

## WORKING SPACES

01



02



03



01  
Steel Manager Desk

02  
Steel Workstation 4P

03  
Steel Workstation 2P



#workingspaces2024

Space Styled, Work Perfected.

# Steel

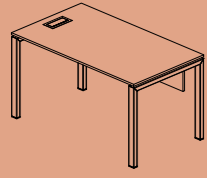

## Single Desk

Width 120/140/160/180  
Depth 70/80  
Height 75

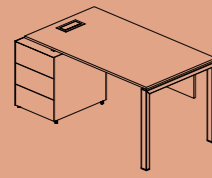

## Single Desk 45

Width 142/162/182/202  
Depth 70/80  
Height 75

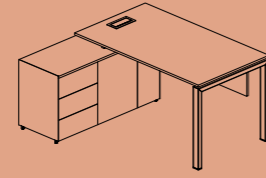

## Single Desk 115

Width 142/162/182/202  
Depth 126  
Height 75

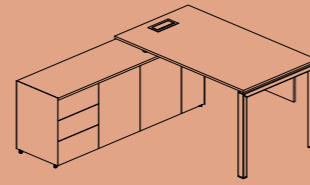

## Single Desk 160

Width 142/162/182/202  
Depth 171  
Height 75

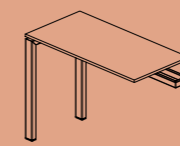

## Single Extension

Width 100  
Depth 50  
Height 75

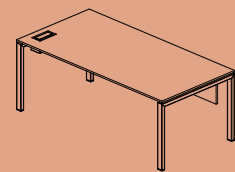

## Manager

Width 200  
Depth 100  
Height 75

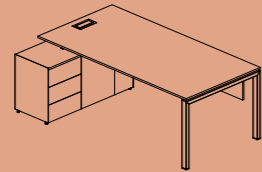

## Manager 115

Width 222  
Depth 126  
Height 75

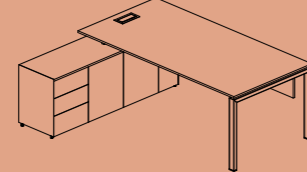

## Manager 160

Width 222  
Depth 171  
Height 75

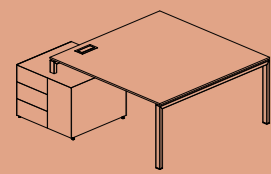

## Manager T 80

Width 140/160  
Depth 180/200  
Height 75  
Table Top Width 140/160  
Table Top Depth 140/160

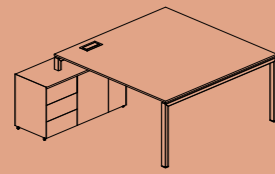

## Manager T 115

Width 185/195  
Depth 162/182  
Height 75  
Table Top Width 140/160  
Table Top Depth 140/160

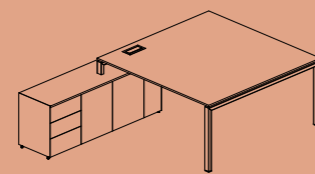

## Manager T 160

Width 230/240  
Depth 162/182  
Height 75  
Table Top Width 140/160  
Table Top Depth 140/160

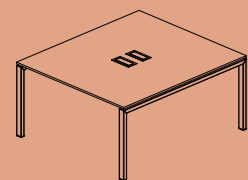

## 2P Workstation

Width 120/140/160/180  
Depth 140/160  
Height 75

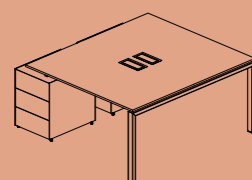

## 2P Workstation 45

Width 142/162/182/202  
Depth 140/160  
Height 75

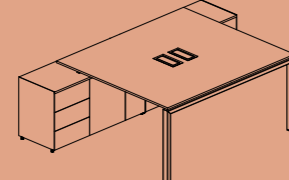

## 2P Workstation 115

Width 142/162/182/202  
Depth 230  
Height 75

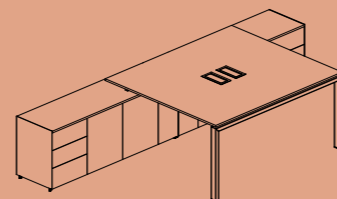

## 2P Workstation 160

Width 142/162/182/202  
Depth 230/320  
Height 75

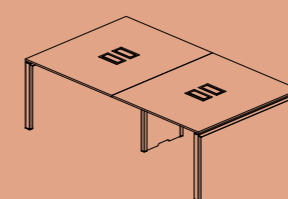

## 4P Workstation

Width 240/280/320/360  
Depth 140/160  
Height 75

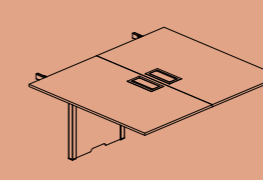

## Workstation Extension

Width 120/140/160/180  
Depth 140/160  
Height 75



#workspaces2024

# Evol

## WORKING SPACES

01



Space Styled,  
Work Perfected.

02



01  
Evol Workstation

02  
Evol Workstation 2P

03



03  
Evol Workstation 4P



#workingspaces2024

# Evol

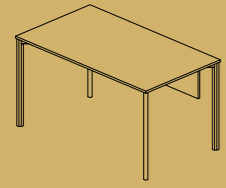

## Single Desk

Width 120/140/160/180  
Depth 70/80  
Height 75

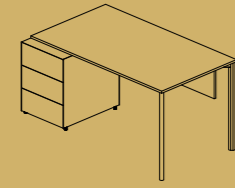

## Single Desk 45

Width 142/162/182/202  
Depth 70/80  
Height 75

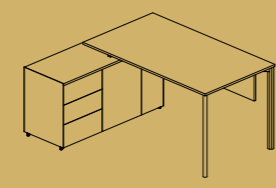

## Single Desk 115

Width 142/162/182/202  
Depth 126  
Height 75

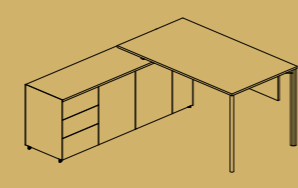

## Single Desk 160

Width 142/162/182/202  
Depth 171  
Height 75

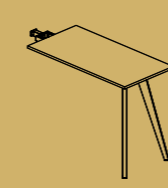

## Single Desk Extension

Width 100  
Depth 50  
Height 75

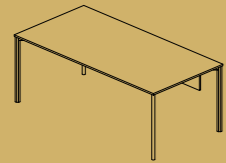

## Manager

Width 200  
Depth 100  
Height 75

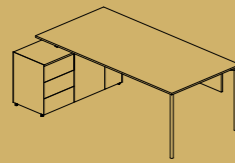

## Manager 115

Width 222  
Depth 126  
Height 75

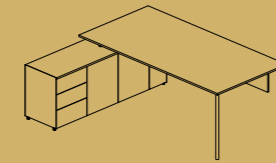

## Manager 160

Width 222  
Depth 171  
Height 75

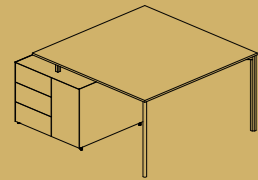

## Manager T 80

Width 140/160  
Depth 180/200  
Height 75  
Table Top Width 140/160  
Table Top Depth 140/160

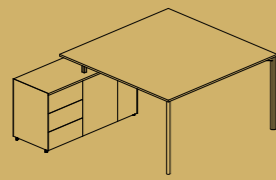

## Manager T 115

Width 185/195  
Depth 162/182  
Height 75  
Table Top Width 140/160  
Table Top Depth 140/160

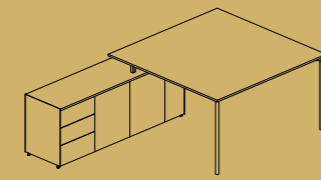

## Manager T 160

Width 230/240  
Depth 162/182  
Height 75  
Table Top Width 140/160  
Table Top Depth 140/160

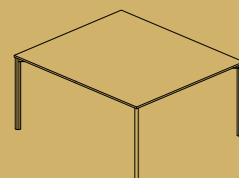

## 2P Workstation

Width 120/140/160/180  
Depth 140/160  
Height 75

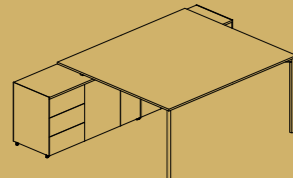

## 2P Workstation 115

Width 142/162/182/202  
Depth 230  
Height 75

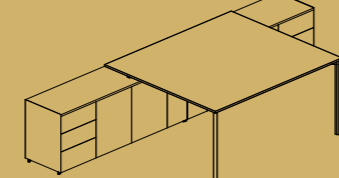

## 2P Workstation 160

Width 142/162/182/202  
Depth 230/320  
Height 75

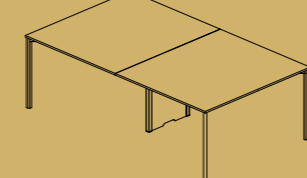

## 4P Workstation

Width 240/280/320/360  
Depth 140/160  
Height 75

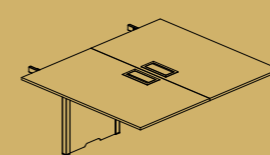

## Workstation Extension

Width 120/140/160/180  
Depth 140/160  
Height 75

Icons representing a desk, a chair, a person, and a monitor.  
#workspaces2024



WORKING SPACES



01



02



03

Up & Down

01  
Up&Down Desk

02  
Up&Down Desk

03  
Up&Down Desk



#workingspaces2024



# Extrude

01



02



Space Styled,  
Work Perfected.

01  
Extrude Desk

02  
Extrude Desk



#workingspaces2024

# Extrude

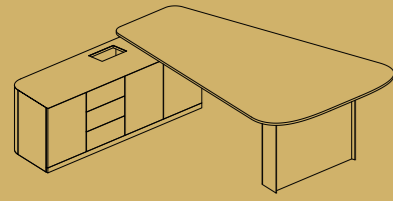

## Executive Desk L/R 210

Width	224
Depth	200
Height	75
Table Top Width	210
Table Top Depth	135
Table Top Height	68/115



#workspaces2024

# Meeting

WORKING  
SPACES



#workspaces2024

# Denis

## MEETING SPACES

01



Space Styled,  
Work Perfected.

01  
Denis Meeting Table

02



#workingspaces2024

# Denis

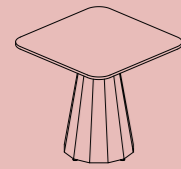

**Desk\_DENIS\_CT\_A**

Width 80/90  
Depth 80/90  
Height 75

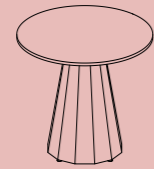

**Desk\_DENIS\_CT\_B**

Dim 80/90  
Height 75

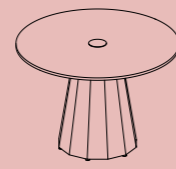

**Desk\_DENIS\_RT\_A**

Dim 110/140  
Height 75

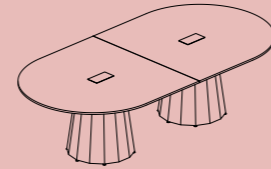

**Desk\_DENIS\_RT\_B**

Width 280/320/340  
Depth 140  
Height 75

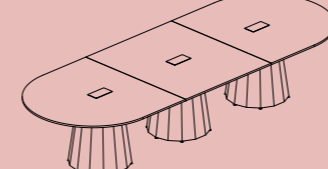

**Desk\_DENIS\_RT\_C**

Width 380/400  
Depth 140  
Height 75

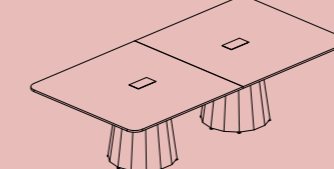

**Desk\_DENIS\_MT\_A**

Width 280/320/340  
Depth 140  
Height 75

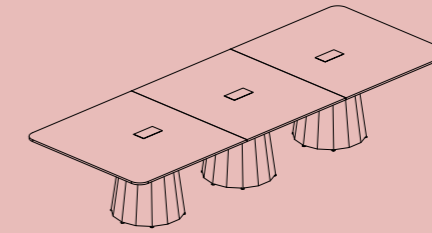

**Desk\_DENIS\_MT\_B**

Width 380/400  
Depth 140  
Height 75



#workspaces2024

# Milan

## MEETING SPACES

01



02



Space Styled,  
Work Perfected.

01  
Milan Meeting Table

02  
Milan-Grand Meeting table



#workingspaces2024

# Milan

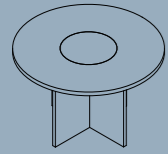

**Meeting Table R:120**

Height	75
Dim	120

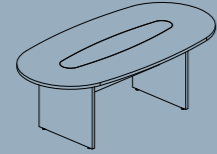

**Meeting Table 220**

Width	220
Depth	110
Height	75

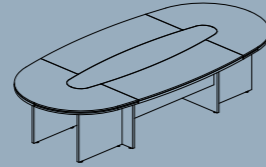

**Meeting Table 350**

Width	350
Depth	170
Height	75

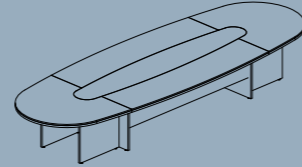

**Meeting Table 500**

Width	500
Depth	170
Height	75



#workingspaces2024

# Loft

## MEETING SPACES

01



02



Space Styled,  
Work Perfected.

01  
Loft Meeting Table



#workingspaces2024

# Loft

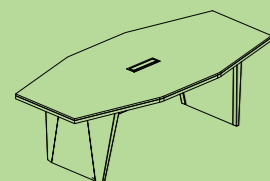

**Meeting Table 220/240/280**

Width 220/240/280  
Depth 120  
Height 77

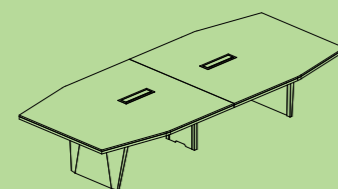

**Meeting Table 320/340/420**

Width 320/340/420  
Depth 150  
Height 77



#workspaces2024



# Informatic

## MEETING SPACES



Space Styled,  
Work Perfected.

01  
Informatic Meeting Table &  
Boost Task Chair

02  
Informatic Meeting  
Table



#workingspaces2024

# Informatic

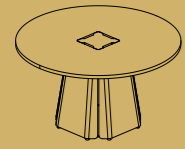

**Meeting Table R140**

Height 75  
Dim 140

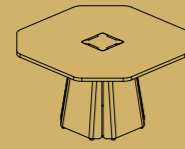

**Meeting Table 135X135**

Width 135  
Depth 135  
Height 75

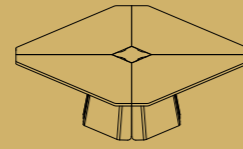

**Meeting Table 200X200**

Width 200  
Depth 200  
Height 75

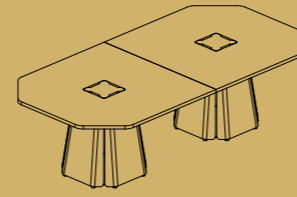

**Meeting Table 270X135**

Width 135  
Depth 270  
Height 75

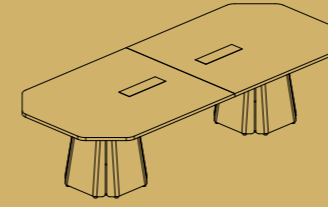

**Meeting Table 320X135**

Width 135  
Depth 320  
Height 75

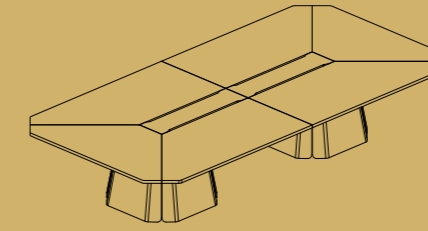

**Meeting Table 400X200**

Width 200  
Depth 400  
Height 75

# Sail

01



02



03



**WORKING  
SPACES**

01  
Sail Meeting

02  
Sail Meeting

03  
Sail Meeting



#workingspaces2024

# Sail

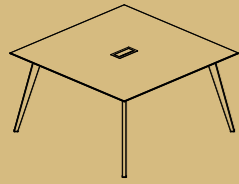

## Meeting

Width 140/160  
Depth 140/160  
Height 75

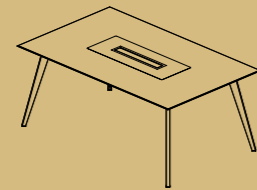

## Meeting

Width 180/200  
Depth 110  
Height 75

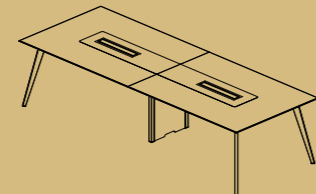

## Meeting

Width 240/280/320  
Depth 110/120  
Height 75

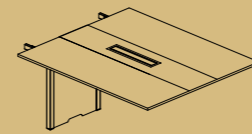

## Meeting Extention

Width 140/160  
Depth 120  
Height 75



#workspaces2024

# Geo

01



02



03



WORKING  
SPACES

01  
Geo Meeting

02  
Geo Meeting

03  
Geo Meeting



#workingspaces2024

# Geo



## Meeting

Width 100  
Depth 100  
Height 75



## Meeting

Width 130  
Depth 130  
Height 75

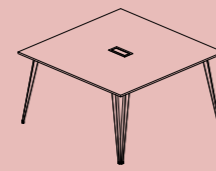

## Meeting

Width 140/160/ø:100/ø:130  
Depth 140/160  
Height 75

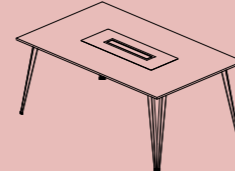

## Meeting

Width 180/200  
Depth 110  
Height 75

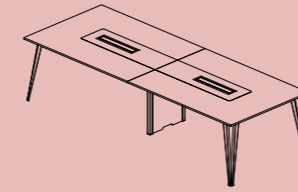

## Meeting

Width 240/280/320  
Depth 110/120  
Height 75

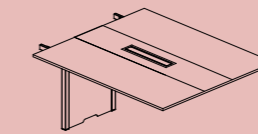

## Meeting Extention

Width 140/160  
Depth 120  
Height 75



#workingspaces2024

# Planet

WORKING  
SPACES

01



02



03



Space Styled,  
Work Perfected.

01  
Planet Meeting

02  
Planet Meeting

03  
Planet Meeting



#workingspaces2024

# Planet

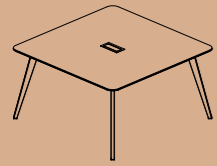

## Meeting R

Width 140/160  
Depth 140/160  
Height 75

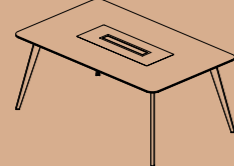

## Meeting R

Width 180/200/240  
Depth 110  
Height 75

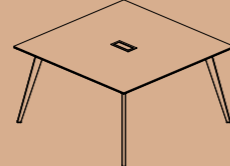

## Meeting

Width 140/160  
Depth 140/160  
Height 75

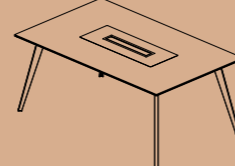

## Meeting

Width 180/200  
Depth 110  
Height 75

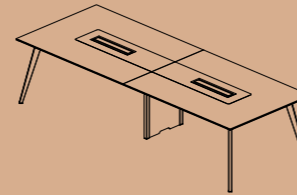

## Meeting

Width 240/280/320  
Depth 110/120  
Height 75

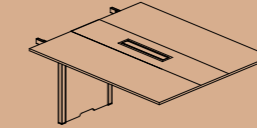

## Meeting Extention

Width 140/160  
Depth 120  
Height 75



#workspaces2024

# Slide

## MEETING SPACES

01



02



03



01  
Slide Meeting

02  
Slide Meeting

03  
Slide Meeting



#workingspaces2024

### Space Styled, Work Perfected.

# Slide

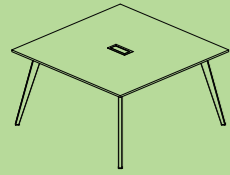

## Meeting

Width 140/160  
Depth 140/160  
Height 75



## Meeting

Depth Ø100/130  
Height 75

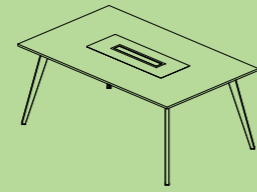

## Meeting

Width 180/200/320  
Depth 110  
Height 75

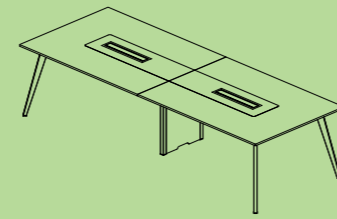

## Meeting

Width 240/280/320  
Depth 120  
Height 75

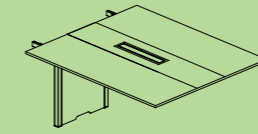

## Meeting Extention

Width 140/160  
Depth 120  
Height 75



#workingspaces2024

# WORKING SPACES

01



02



03



# Polo

01  
Polo Meeting

02  
Polo Meeting

03  
Polo Meeting



#workingspaces2024

# Polo

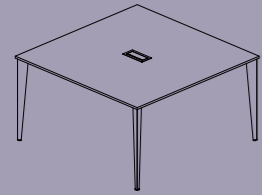

## Meeting

Width 140/160  
Depth 140/160  
Height 75

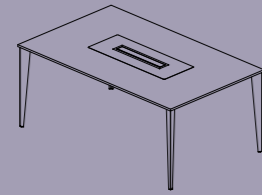

## Meeting

Width 180/200/240  
Depth 110  
Height 75

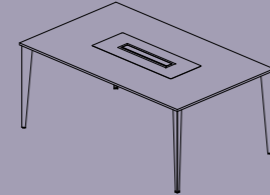

## Meeting

Width 280/320  
Depth 120  
Height 75

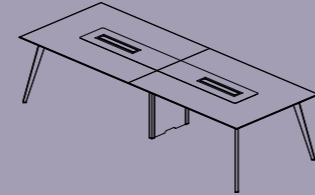

## Meeting

Width 240/280/320  
Depth 110/120  
Height 75

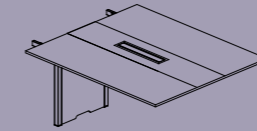

## Meeting Extention

Width 140/160  
Depth 120  
Height 75

# Steel

## WORKING SPACES



01  
Steel Meeting

02  
Steel Meeting

03  
Steel Meeting



#workingspaces2024

Space Styled, Work Perfected.

# Steel

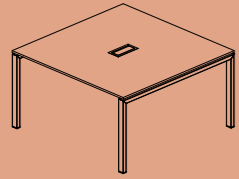

## Meeting

Width 140/160  
Depth 140/160  
Height 75

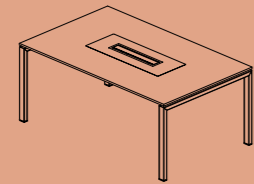

## Meeting

Width 180/200  
Depth 110  
Height 75

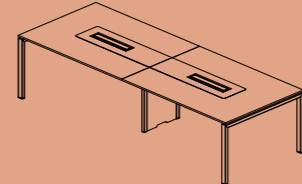

## Meeting

Width 240/280/320  
Depth 120  
Height 75

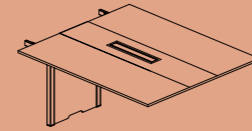

## Meeting Extention

Width 140/160  
Depth 120  
Height 75

# Evol

## WORKING SPACES

01



02



03



01  
Evol Meeting

02  
Evol Meeting

03  
Evol Meeting



#workingspaces2024

### Space Styled, Work Perfected.

# Evol

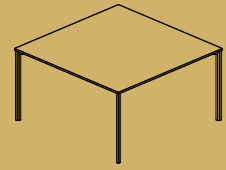

## Meeting

Width 140/160  
Depth 140/160  
Height 75

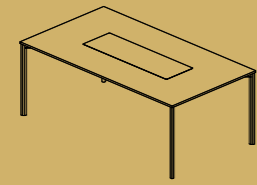

## Meeting

Width 180/200  
Depth 110  
Height 75

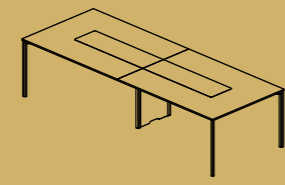

## Meeting

Width 240/280/320  
Depth 120  
Height 75

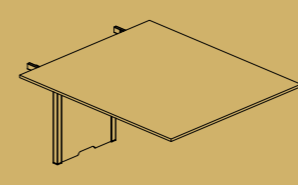

## Meeting Extention

Width 140/160  
Depth 120  
Height 75

# PlanetR

## WORKING SPACES

01



02



03



01  
PlanetR Meeting

02  
PlanetR Meeting

03  
PlanetR Meeting



#workingspaces2024

Space Styled, Work Perfected.

# PlanetR

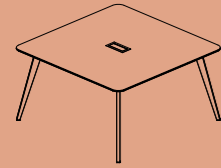

## Meeting

Width 140/160  
Depth 140/160  
Height 75

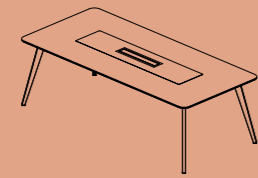

## Meeting

Width 180/200  
Depth 110  
Height 75

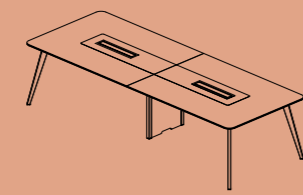

## Meeting

Width 240/280/320  
Depth 110/120  
Height 75

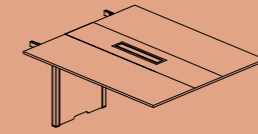

## Meeting Extention

Width 140/160  
Depth 120  
Height 75

# Space

## MEETING SPACES

01



02



Space Styled,  
Work Perfected.

01  
Space High Desk

02  
Space High Desk



#workingspaces2024

# Space

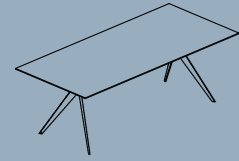

## Space Meeting 180/200/240

Width	180/200/240
Depth	100
Height	75



# Valens

## MEETING SPACES

01



02



Space Styled,  
Work Perfected.

01  
Valens Meeting

02  
Valens Meeting



#workingspaces2024

# Valens

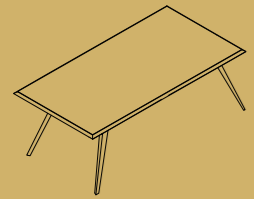

**Meeting Table 210/240**

Width 210/240  
Depth 110  
Height 75

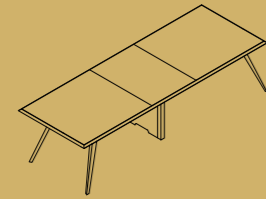

**Meeting Table 280**

Width 280  
Depth 120  
Height 75

# High Desk

WORKING  
SPACES



# Sail

## WORKING SPACES

01



02



03



WORKING  
SPACES

01  
Sail High Desk

02  
Sail High Desk

03  
Sail High Desk



#workingspaces2024

# Sail

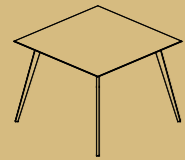

## High Desk

Width 140/160  
Depth 140/160  
Height 105

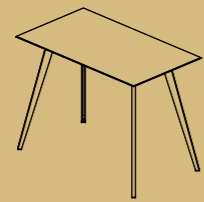

## High Desk

Width 140/160/180  
Depth 80  
Height 105

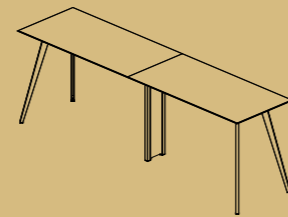

## High Desk

Width 320/360/420  
Depth 80  
Height 105

# Planet

## WORKING SPACES

01



02



03



Space Styled,  
Work Perfected.

01  
Planet High Desk

02  
Planet High Desk

03  
Planet High Desk



#workingspaces2024

# Planet

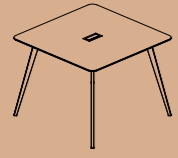

## High Desk R

Width 140/160  
Depth 140/160  
Height 105



## High Desk R

Width 140/160/180  
Depth 80  
Height 105

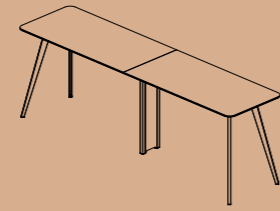

## High Desk R

Width 320/360/420  
Depth 80  
Height 105

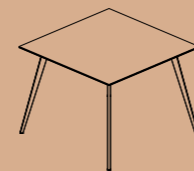

## High Desk

Width 140/160/180  
Depth 80  
Height 105



## High Desk

Width 140/160/180  
Depth 80  
Height 105

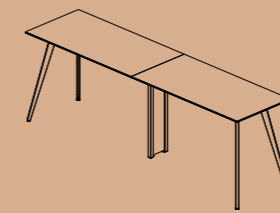

## High Desk

Width 140/160/180  
Depth 80  
Height 105



#workingspaces2024

# PlanetR

## WORKING SPACES

01



02



03



01  
PlanetR High Desk

02  
PlanetR High Desk

03  
PlanetR High Desk



#workingspaces2024

Space Styled, Work Perfected.

# PlanetR

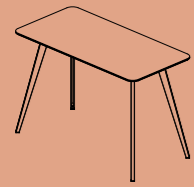

## High Desk

Width 140/160/180  
Depth 80  
Height 105

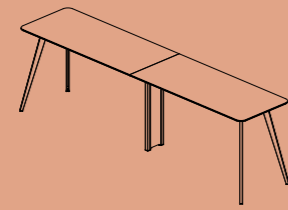

## High Desk

Width 320/360/420  
Depth 80  
Height 105

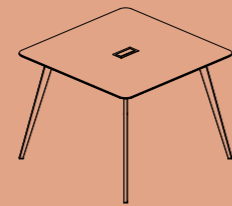

## High Desk

Width 140/160  
Depth 140/160  
Height 105



# Slide

01



02



03



WORKING  
SPACES

01  
Slide High Desk

02  
Slide High Desk

03  
Slide High Desk



#workingspaces2024

# Slide



## High Desk

Width 140/160  
Depth 140/160  
Height 105



## High Desk

Width 140/160/180  
Depth 80  
Height 105

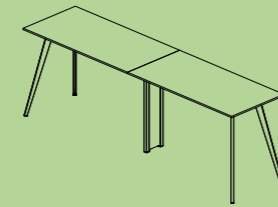

## High Desk

Width 320/360/420  
Depth 80  
Height 105

# Steel

## WORKING SPACES

01



02



03



01  
Steel High Desk

02  
Steel High Desk

03  
Steel High Desk



#workingspaces2024

Space Styled, Work Perfected.

# Steel

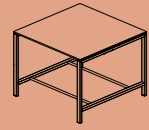

## High Desk

Width 140/160  
Depth 140/160  
Height 105

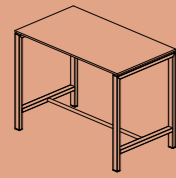

## High Desk

Width 140/160/180  
Depth 80  
Height 105

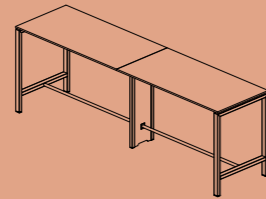

## High Desk

Width 320/360/420  
Depth 80  
Height 105



#workingspaces2024

# Denis

01



02



03



WORKING  
SPACES

01  
Denis High Desk

02  
Denis High Desk

03  
Denis High Desk



#workingspaces2024

# Denis

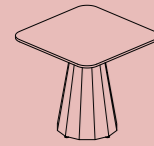

**Desk\_DENIS\_CT\_A**

Width 80/90  
Depth 80/90  
Height 75

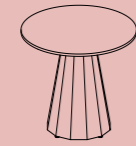

**Desk\_DENIS\_CT\_B**

Dim 80/90  
Height 75

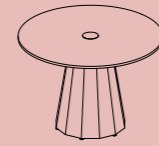

**Desk\_DENIS\_RT\_A**

Dim 110/140  
Height 75

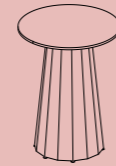

**Executive\_Desk\_RHT180**

Dim 80  
Height 105

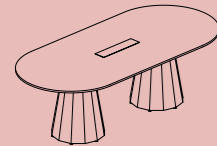

**Desk\_DENIS\_RT\_240110**

Width 240  
Depth 110  
Height 75

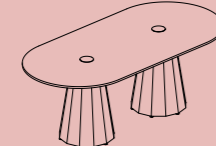

**Desk\_DENIS\_RT\_210100**

Width 210  
Depth 100  
Height 75

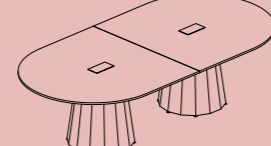

**Desk\_DENIS\_RT\_B**

Width 280/320/340  
Depth 140  
Height 75

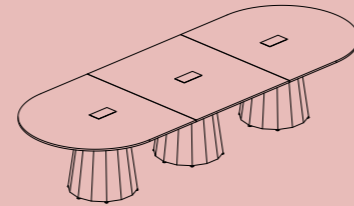

**Desk\_DENIS\_RT\_C**

Width 380/400  
Depth 140  
Height 75



**Desk\_DENIS\_RHT\_110**

Dim 110  
Height 105

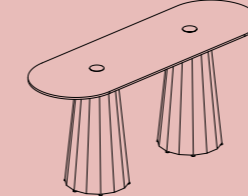

**Desk\_DENIS\_RHT\_110**

Width 180  
Depth 80  
Height 105



**Desk\_DENIS\_RHT\_110**

Width 180  
Depth 80  
Height 105

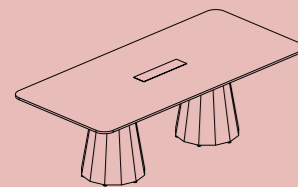

**Desk\_DENIS\_RT\_210/240**

Width 210/240  
Depth 100/110  
Height 75

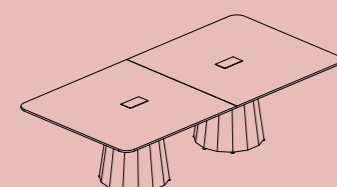

**Desk\_DENIS\_MT\_A**

Width 280/320/340  
Depth 140  
Height 75

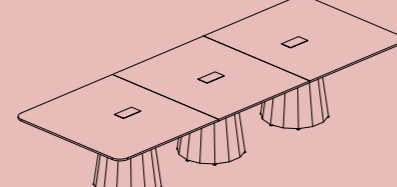

**Desk\_DENIS\_MT\_B**

Width 380/400  
Depth 140  
Height 75

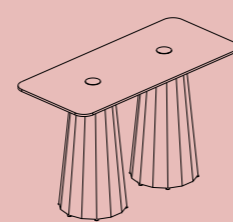

**Desk\_DENIS\_RHT\_240110**

Width 240  
Depth 105  
Height 110

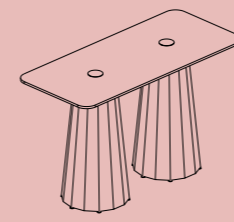

**Desk\_DENIS\_MHT\_18080**

Width 180  
Depth 105  
Height 80

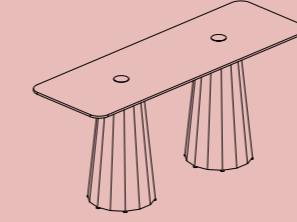

**Desk\_DENIS\_MHT\_24080**

Width 240  
Depth 110  
Height 80

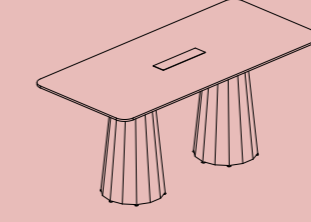

**Desk\_DENIS\_MHT\_240110**

Width 240  
Depth 105  
Height 110

# Timy

01



WORKING  
SPACES

01  
Timy High Desk



#workingspaces2024

# Timy



**Desk\_Timy\_ATL\_16080\_H90**

Width 160  
Depth 80  
Height 90

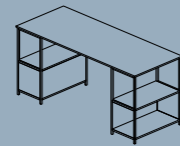

**Desk\_Timy\_ATL\_20080\_H90**

Width 200  
Depth 80  
Height 90

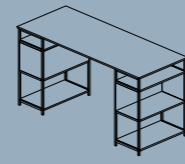

**Desk\_Timy\_ATL\_20080\_H105**

Width 200  
Depth 80  
Height 105

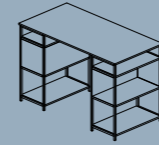

**Desk\_Timy\_ATL\_161080\_H105**

Width 160  
Depth 80  
Height 105

# Seminar Desk

WORKING  
SPACES

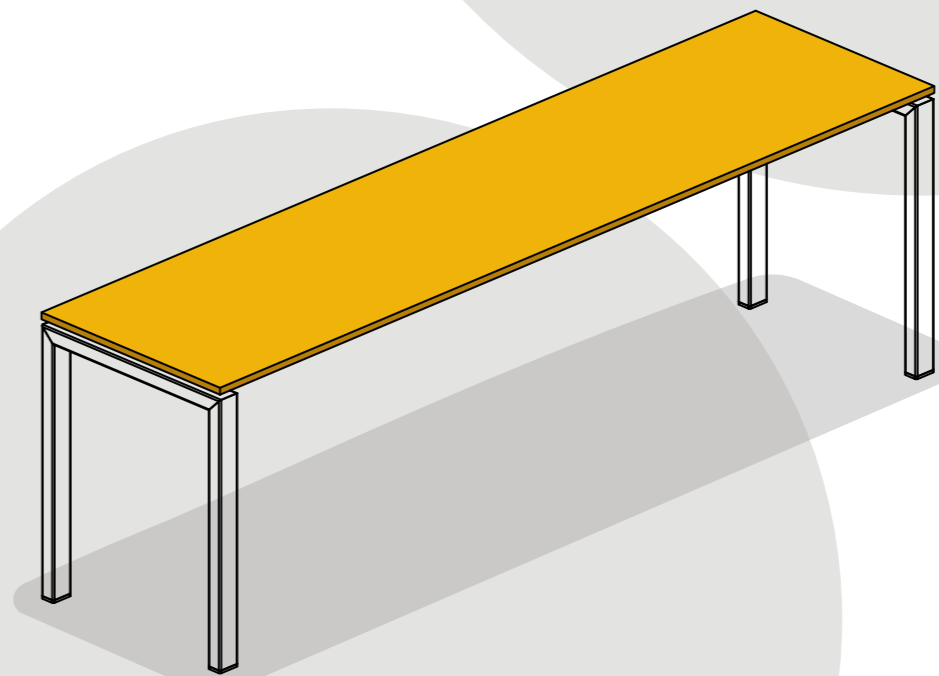
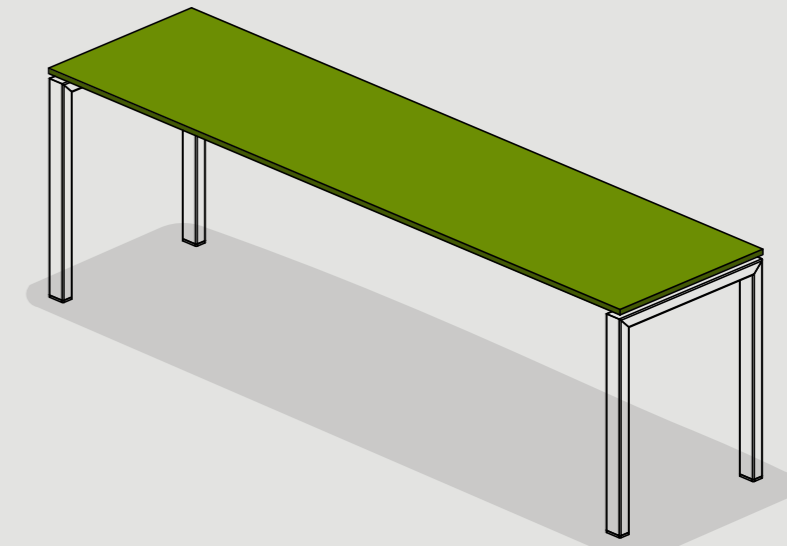

#workingspaces2024

# Steel

## WORKING SPACES

01



02



01  
Steel Seminar Desk

02  
Steel Seminar Desk



#workingspaces2024

Space Styled, Work Perfected.

# Steel

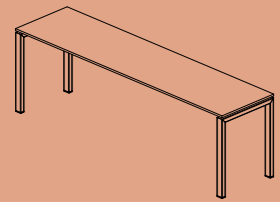

## Seminer Desk

Width	240/280/360/420
Depth	60
Height	75

# Evol

## WORKING SPACES

01



02



01  
Evol Seminar Desk

02  
Evol Seminar Desk



#workingspaces2024

### Space Styled, Work Perfected.

# Evol

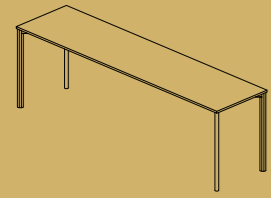

## Seminer Desk

Width	240/280/360/420
Depth	60
Height	75

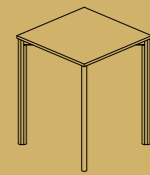

## Dynamic Conference

Width	60/120/140/280
Depth	60
Height	75

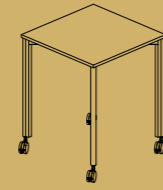

## Dynamic Conference

Width	60/120/140/280
Depth	60
Height	75

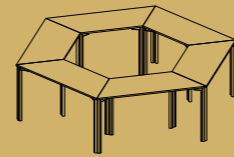

## Dynamic Conference

Width	280
Depth	242
Height	75

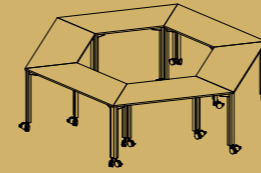

## Dynamic Conference

Width	280
Depth	242
Height	75

# Storage

WORKING  
SPACES

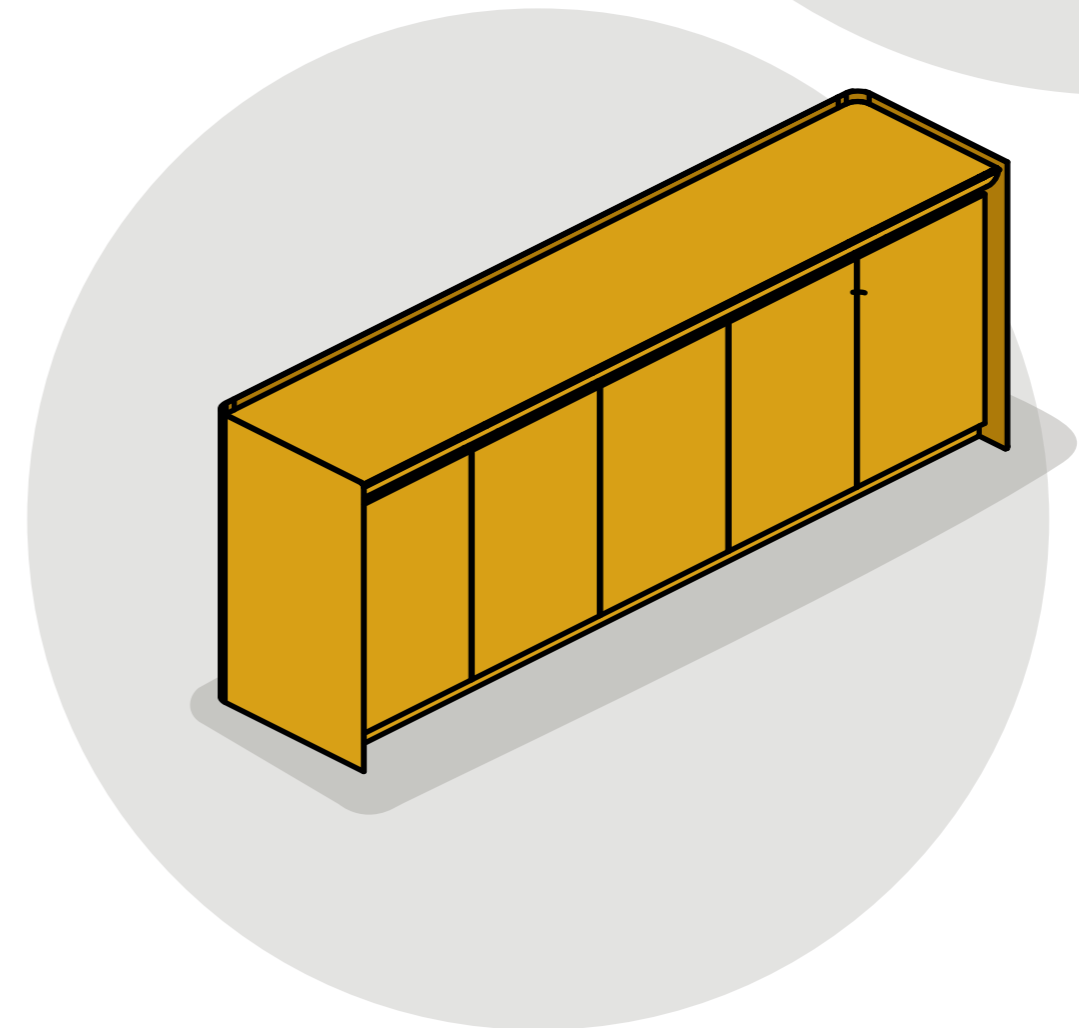
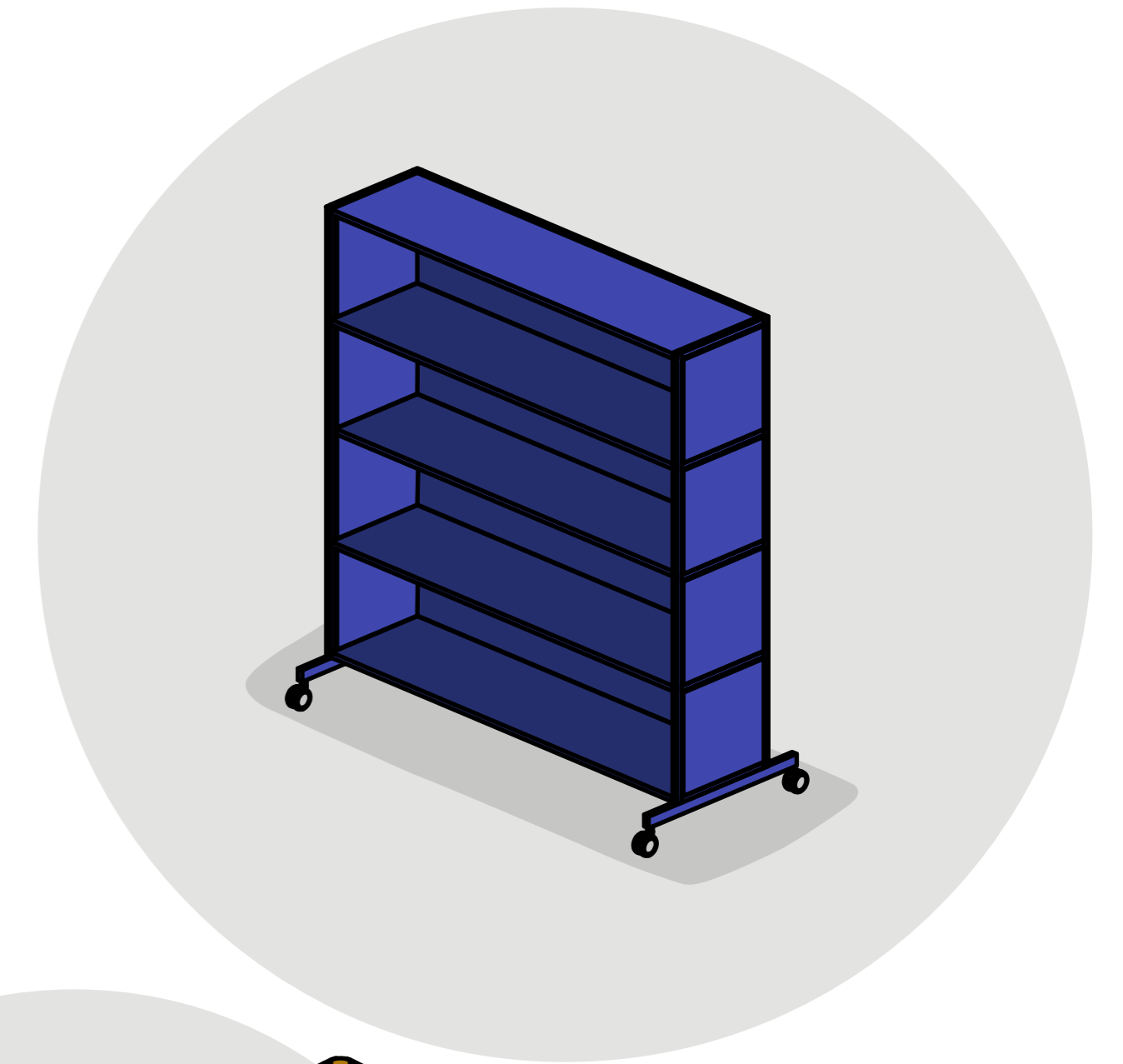

#workspaces2024

# Layer

01



02



03



Space Styled,  
Work Perfected.

01  
Layer Focus Cabine

02  
Layer Booth

03  
Layer Recycle Cabinet



#workingspaces2024

# Layer

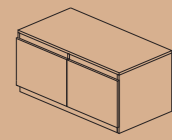

**Storage\_LAYER\_100H47\_OC**

Width 100  
Depth 54  
Height 47

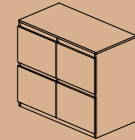

**Storage\_LAYER\_100H87\_OC**

Width 100  
Depth 54  
Height 87



**Storage\_LAYER\_100H127\_OC**

Width 100  
Depth 54  
Height 127

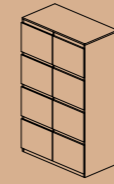

**Storage\_LAYER\_100H167\_OC**

Width 100  
Depth 54  
Height 167

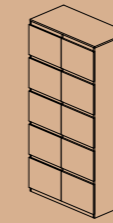

**Storage\_LAYER\_100H207\_OC\_10C**

Width 100  
Depth 54  
Height 207

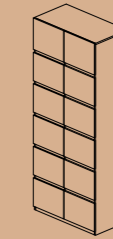

**Storage\_LAYER\_100H245\_OC\_12C**

Width 100  
Depth 54  
Height 245

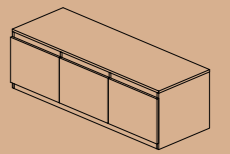

**Storage\_LAYER\_150H47\_OC**

Width 150  
Depth 54  
Height 47

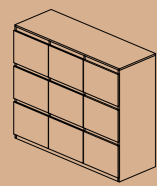

**Storage\_LAYER\_150H127\_OC**

Width 150  
Depth 54  
Height 127

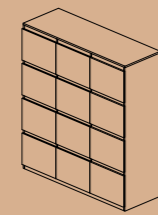

**Storage\_LAYER\_150H167\_OC**

Width 150  
Depth 54  
Height 167

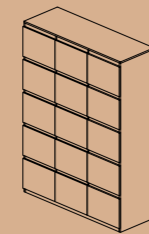

**Storage\_LAYER\_150H207\_OC\_15C**

Width 150  
Depth 54  
Height 207

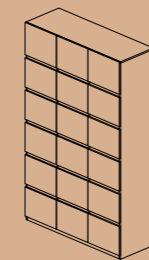

**Storage\_LAYER\_150H245\_OC\_18C**

Width 150  
Depth 54  
Height 245

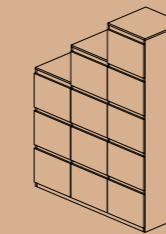

**Storage\_LAYER\_150H207\_OC\_ZigZag\_R**

Width 150  
Depth 54  
Height 207

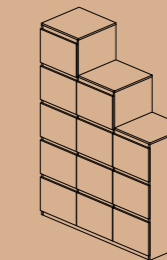

**Storage\_LAYER\_150H207\_OC\_ZigZag\_L**

Width 150  
Depth 54  
Height 207

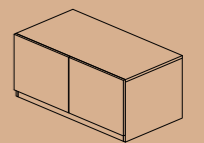

**Storage\_LAYER\_100H45**

Width 100  
Depth 54  
Height 45

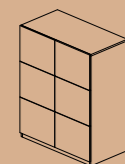

**Storage\_LAYER\_100H125**

Width 100  
Depth 54  
Height 125

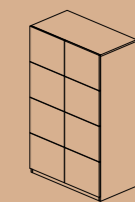

**Storage\_LAYER\_100H165**

Width 100  
Depth 54  
Height 165

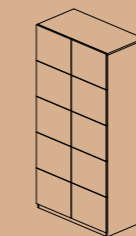

**Storage\_LAYER\_100H205\_10C**

Width 100  
Depth 54  
Height 205

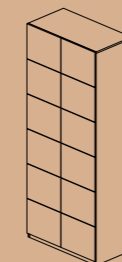

**Storage\_LAYER\_100H245\_12C**

Width 100  
Depth 54  
Height 245

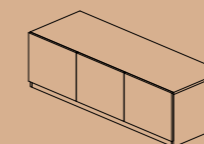

**Storage\_LAYER\_150H45**

Width 150  
Depth 54  
Height 45

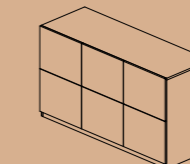

**Storage\_LAYER\_150H85**

Width 150  
Depth 54  
Height 85

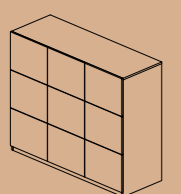

**Storage\_LAYER\_150H125**

Width 150  
Depth 54  
Height 125

# Layer

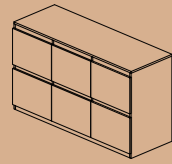

**Storage\_LAYER\_150H87\_OC**

Width 100  
Depth 54  
Height 87

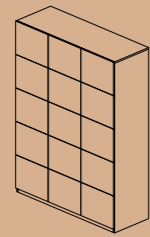

**Storage\_LAYER\_150H205\_15C**

Width 150  
Depth 54  
Height 205

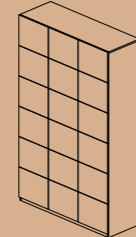

**Storage\_LAYER\_150H245\_18C**

Width 150  
Depth 54  
Height 245

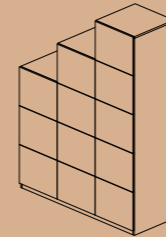

**Storage\_LAYER\_150H205\_ZigZag\_R**

Width 150  
Depth 54  
Height 205

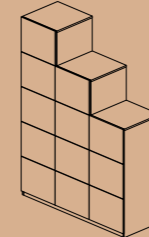

**Storage\_LAYER\_150H205\_ZigZag\_L**

Width 150  
Depth 54  
Height 205

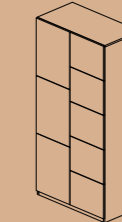

**Storage\_LAYER\_100H205\_MIX\_8C**

Width 100  
Depth 54  
Height 205

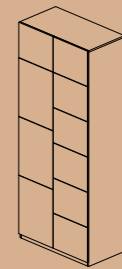

**Storage\_LAYER\_100H245\_MIX\_10C**

Width 100  
Depth 54  
Height 245

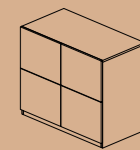

**Storage\_LAYER\_100H85**

Width 100  
Depth 54  
Height 85

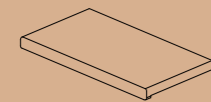

**Storage\_LAYER\_100\_PILLOW**

Width 100  
Depth 55  
Height 7

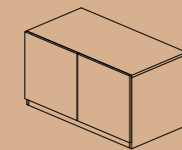

**Storage\_LAYER\_100H55**

Width 100  
Depth 54  
Height 55

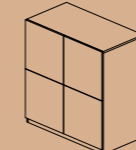

**Storage\_LAYER\_100H105**

Width 100  
Depth 54  
Height 105

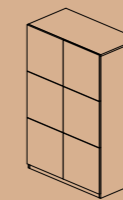

**Storage\_LAYER\_100H155**

Width 100  
Depth 54  
Height 155

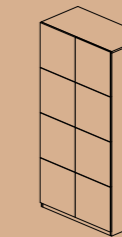

**Storage\_LAYER\_100H205\_8C**

Width 100  
Depth 54  
Height 205

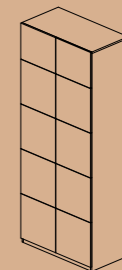

**Storage\_LAYER\_100H245\_10C**

Width 100  
Depth 54  
Height 245

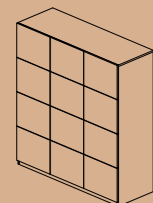

**Storage\_LAYER\_150H165**

Width 150  
Depth 54  
Height 165

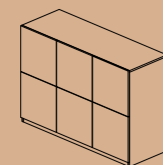

**Storage\_LAYER\_150H105**

Width 150  
Depth 54  
Height 105

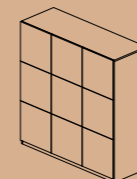

**Storage\_LAYER\_150H155**

Width 150  
Depth 54  
Height 155

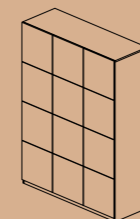

**Storage\_LAYER\_150H205\_12C**

Width 150  
Depth 54  
Height 205

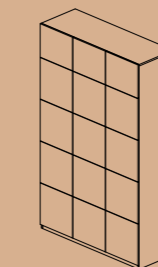

**Storage\_LAYER\_150H245\_15C**

Width 150  
Depth 54  
Height 245

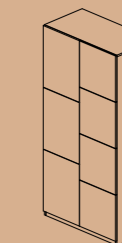

**Storage\_LAYER\_100H205\_MIX\_7C**

Width 100  
Depth 54  
Height 205

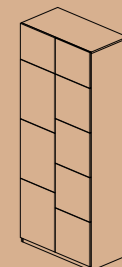

**Storage\_LAYER\_100H245\_MIX\_9C**

Width 100  
Depth 54  
Height 245

# Layer

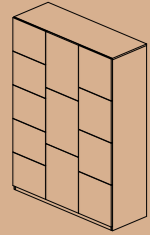

**Storage\_LAYER\_150H205\_MIX\_12C1**

Width 150  
Depth 54  
Height 205

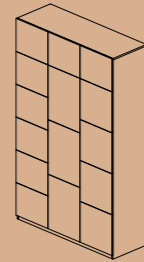

**Storage\_LAYER\_150H245\_MIX\_15C1**

Width 150  
Depth 54  
Height 245

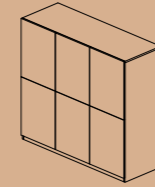

**Stroge\_LAYER\_100H71**

Width 100  
Depth 54  
Height 71

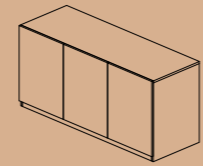

**Stroge\_LAYER\_100H138**

Width 100  
Depth 54  
Height 138

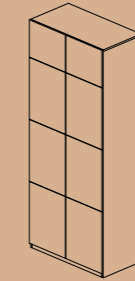

**Stroge\_LAYER\_100H205\_6C**

Width 100  
Depth 54  
Height 205

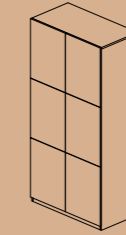

**Stroge\_LAYER\_100H245\_8C**

Width 100  
Depth 54  
Height 245

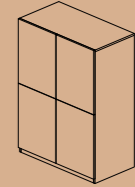

**Storage\_LAYER\_150H71**

Width 150  
Depth 54  
Height 71

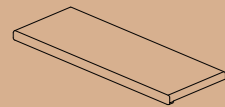

**Storage\_LAYER\_150\_PILLOW**

Width 150  
Depth 55  
Height 7

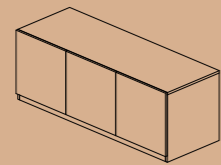

**Storage\_LAYER\_150H55**

Width 150  
Depth 54  
Height 55

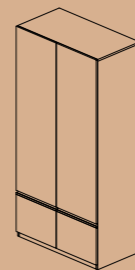

**Storage\_LAYER\_100H205\_MIX\_9C**

Width 100  
Depth 54  
Height 205

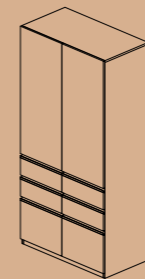

**Storage\_LAYER\_100H245\_MIX\_11C**

Width 100  
Depth 54  
Height 245

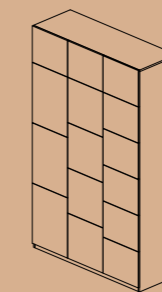

**Storage\_LAYER\_150H205\_MIX\_12C**

Width 150  
Depth 54  
Height 205

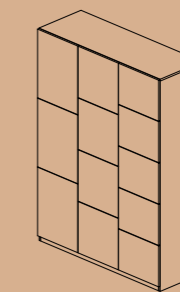

**Storage\_LAYER\_150H245\_MIX\_15C**

Width 150  
Depth 54  
Height 245



**Storage\_LAYER\_100H205\_LIB\_6D**

Width 100  
Depth 54  
Height 205

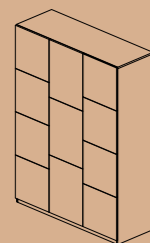

**Storage\_LAYER\_150H205\_MIX\_11C**

Width 150  
Depth 54  
Height 205

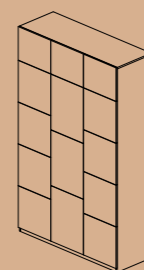

**Storage\_LAYER\_150H245\_MIX\_14C**

Width 150  
Depth 54  
Height 245

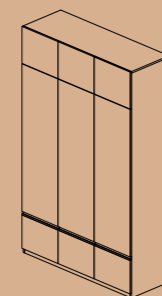

**Storage\_LAYER\_100H205\_VES\_6D**

Width 100  
Depth 54  
Height 205

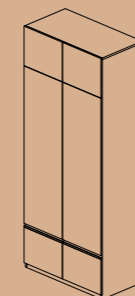

**Storage\_LAYER\_100H245\_LIB**

Width 100  
Depth 54  
Height 245

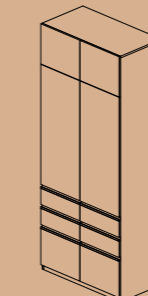

**Storage\_LAYER\_100H245\_LIB\_4D**

Width 100  
Depth 54  
Height 245

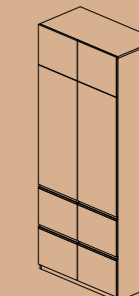

**Storage\_LAYER\_100H245\_LIB\_6D**

Width 100  
Depth 54  
Height 245

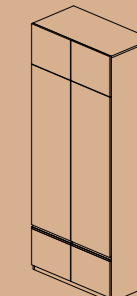

**Storage\_LAYER\_100H245\_VES**

Width 100  
Depth 54  
Height 245

# Layer

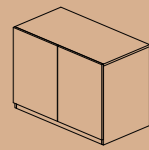

**Storage\_LAYER\_150H138**

Width 150  
Depth 54  
Height 138

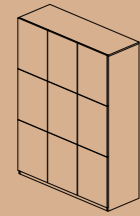

**Storage\_LAYER\_150H205\_9C**

Width 150  
Depth 54  
Height 205

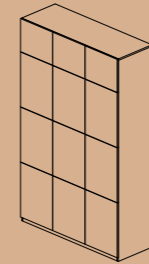

**Storage\_LAYER\_150H245\_12C**

Width 150  
Depth 54  
Height 245

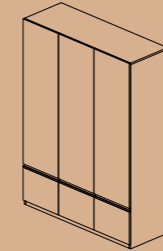

**Storage\_LAYER\_150H205\_LIB\_3D**

Width 150  
Depth 54  
Height 205

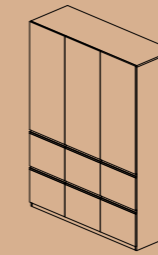

**Storage\_LAYER\_150H205\_LIB\_6D**

Width 150  
Depth 54  
Height 205

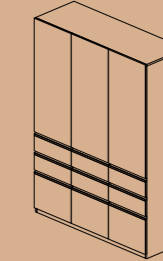

**Storage\_LAYER\_150H205\_LIB\_9D**

Width 150  
Depth 54  
Height 205

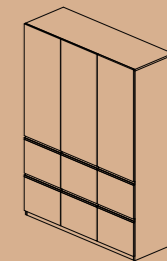

**Storage\_LAYER\_150H205\_VES\_6D**

Width 150  
Depth 54  
Height 205

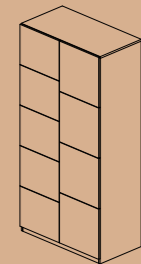

**Storage\_LAYER\_100H205\_VES**

Width 100  
Depth 54  
Height 245

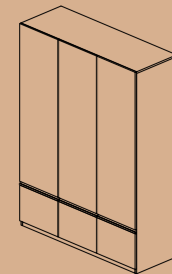

**Storage\_LAYER\_150H205\_VES\_3D**

Width 150  
Depth 54  
Height 205

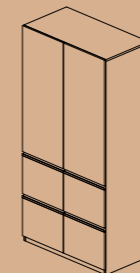

**Storage\_LAYER\_100H205\_VES\_4D**

Width 100  
Depth 54  
Height 205

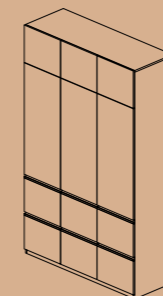

**Storage\_LAYER\_150H245\_VES\_6D**

Width 150  
Depth 54  
Height 245

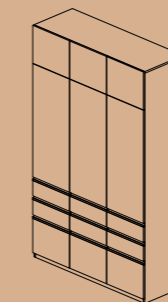

**Storage\_LAYER\_150H245\_VES\_9D**

Width 150  
Depth 54  
Height 245

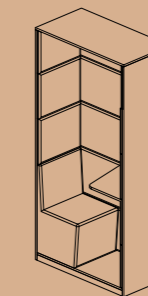

**Storage\_LAYER\_100H205\_BTH\_L**

Width 100  
Depth 52  
Height 205

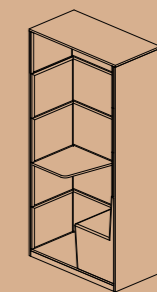

**Storage\_LAYER\_100H205\_BTH\_R**

Width 100  
Depth 52  
Height 205

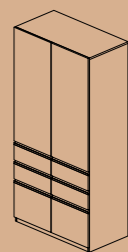

**Storage\_LAYER\_150H245\_VES\_3D**

Width 150  
Depth 54  
Height 245

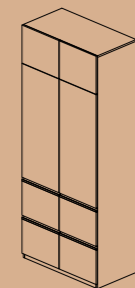

**Storage\_LAYER\_100H245\_VES\_4D**

Width 100  
Depth 54  
Height 245

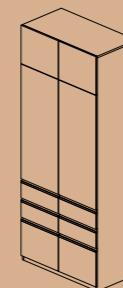

**Storage\_LAYER\_100H245\_VES\_6D**

Width 100  
Depth 54  
Height 245

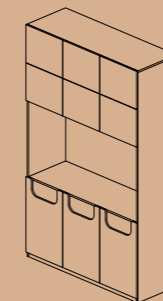

**Storage\_LAYER\_150H245\_T**

Width 150  
Depth 54  
Height 245

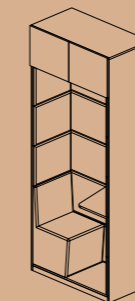

**Storage\_LAYER\_100H245\_BTH\_L**

Width 100  
Depth 54  
Height 245

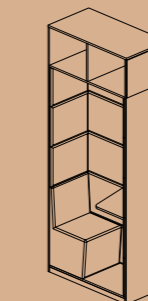

**Storage\_LAYER\_100H245\_BTH\_L\_O**

Width 100  
Depth 52  
Height 245

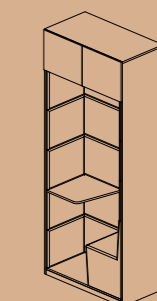

**Storage\_LAYER\_100H245\_BTH\_R**

Width 100  
Depth 54  
Height 245

# Layer

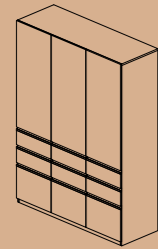

**Storage\_LAYER\_150H205\_VES\_9D**

Width 150  
Depth 54  
Height 205

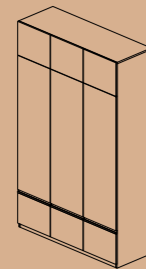

**Storage\_LAYER\_150H245\_LIB\_3D**

Width 150  
Depth 54  
Height 245

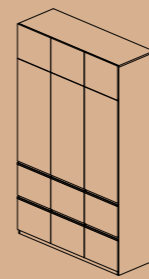

**Storage\_LAYER\_150H245\_LIB\_6D**

Width 150  
Depth 54  
Height 245

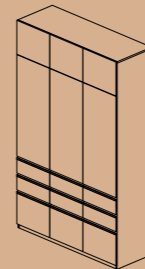

**Storage\_LAYER\_150H245\_LIB\_9D**

Width 150  
Depth 54  
Height 245

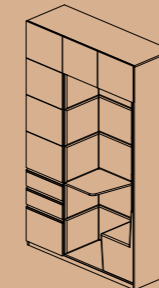

**Storage\_LAYER\_150H245\_BTH\_R**

Width 150  
Depth 54  
Height 245

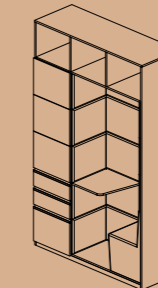

**Storage\_LAYER\_150H245\_BTH\_R\_O**

Width 150  
Depth 54  
Height 245

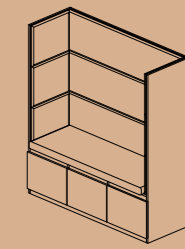

**Storage\_LAYER\_150H165\_OC\_S**

Width 150  
Depth 57  
Height 165

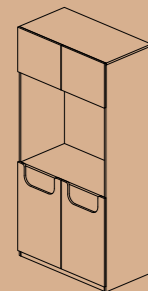

**Storage\_LAYER\_100H205\_T**

Width 100  
Depth 54  
Height 205

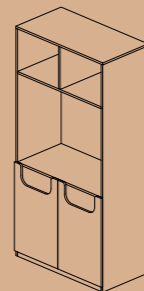

**Storage\_LAYER\_100H205\_T\_SO**

Width 100  
Depth 54  
Height 205

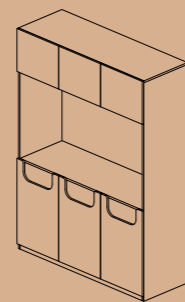

**Storage\_LAYER\_150H205\_T**

Width 150  
Depth 54  
Height 205

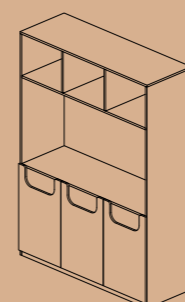

**Storage\_LAYER\_150H205\_T\_SO**

Width 150  
Depth 54  
Height 205

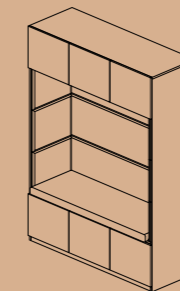

**Storage\_LAYER\_150H205\_S**

Width 150  
Depth 57  
Height 205

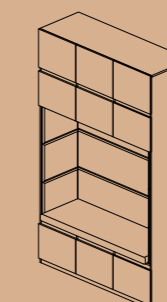

**Storage\_LAYER\_150H245\_OC\_S**

Width 150  
Depth 57  
Height 245

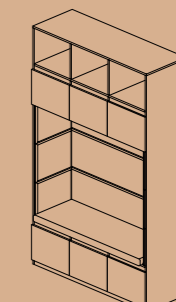

**Storage\_LAYER\_150H245\_OC\_SO**

Width 150  
Depth 57  
Height 245

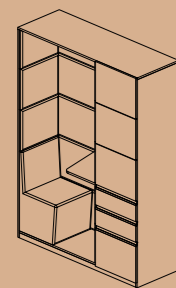

**Storage\_LAYER\_150H205\_BTH\_L**

Width 100  
Depth 54  
Height 205

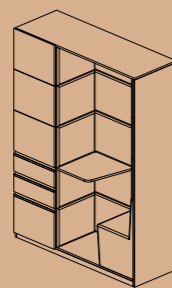

**Storage\_LAYER\_150H205\_BTH\_R**

Width 150  
Depth 54  
Height 205

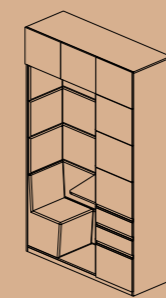

**Storage\_LAYER\_150H245\_BTH\_L**

Width 150  
Depth 54  
Height 245

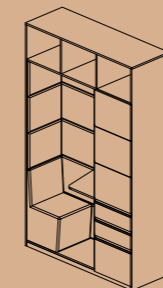

**Storage\_LAYER\_150H245\_BTH\_L\_O**

Width 150  
Depth 54  
Height 245

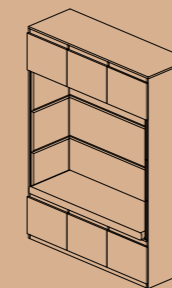

**Storage\_LAYER\_150H205\_OC\_S**

Width 150  
Depth 57  
Height 205

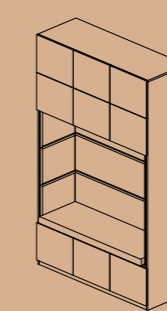

**Storage\_LAYER\_150H245\_S**

Width 150  
Depth 57  
Height 245

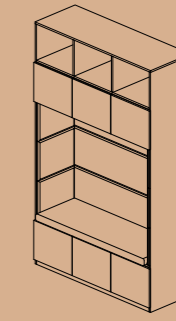

**Storage\_LAYER\_150H245\_SO**

Width 150  
Depth 57  
Height 245

# Layer

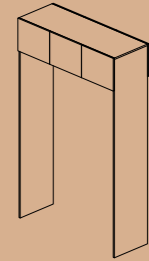

**Storage\_LAYER\_150H245\_G**

Width 150  
Depth 57  
Height 245

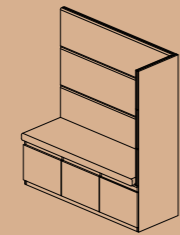

**Storage\_LAYER\_150H165\_OC\_SL**

Width 150  
Depth 57  
Height 165

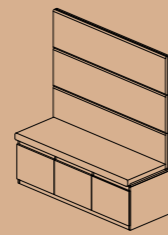

**Storage\_LAYER\_150H165\_OC\_SM**

Width 150  
Depth 57  
Height 165

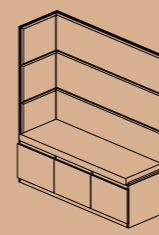

**Storage\_LAYER\_150H165\_OC\_SR**

Width 150  
Depth 57  
Height 165

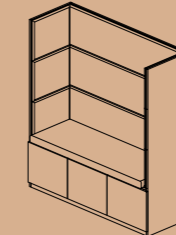

**Storage\_LAYER\_150H165\_S**

Width 150  
Depth 57  
Height 165

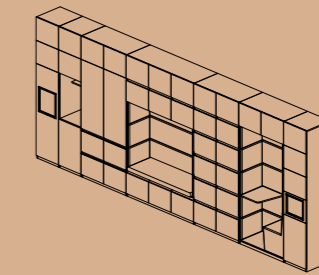

**LAYER\_LOCKER\_SET1**

Width 600  
Depth 57  
Height 245

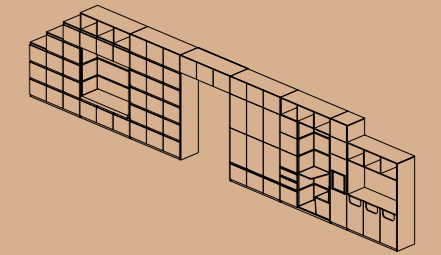

**LAYER\_LOCKER\_SET2**

Width 11000  
Depth 54  
Height 245

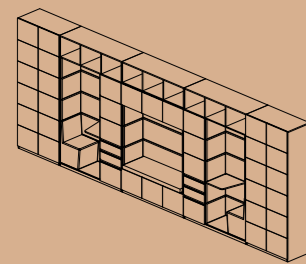

**LAYER\_LOCKER\_SET3**

Width 650  
Depth 57  
Height 245

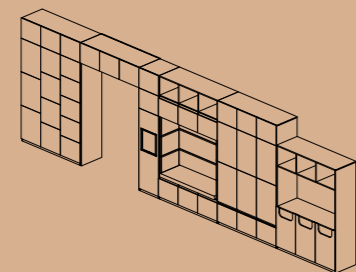

**LAYER\_LOCKER\_SET4**

Width 800  
Depth 57  
Height 245

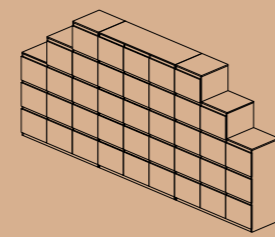

**LAYER\_LOCKER\_SET5**

Width 450  
Depth 54  
Height 205

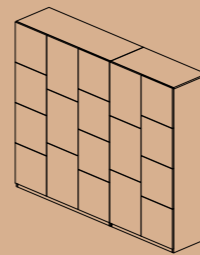

**LAYER\_LOCKER\_SET6**

Width 250  
Depth 54  
Height 205

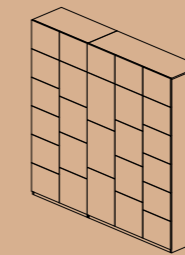

**LAYER\_LOCKER\_SET7**

Width 250  
Depth 54  
Height 245

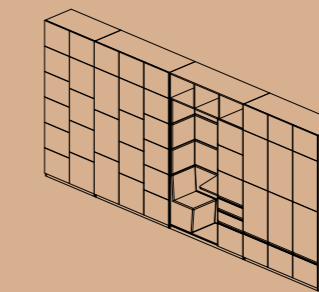

**LAYER\_LOCKER\_SET8**

Width 550  
Depth 54  
Height 245

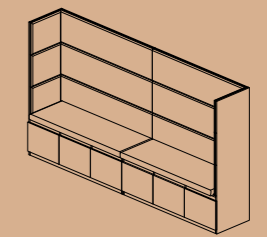

**LAYER\_LOCKER\_SET9**

Width 300  
Depth 57  
Height 165

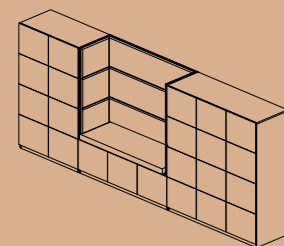

**LAYER\_LOCKER\_SET10**

Width 400  
Depth 57  
Height 165

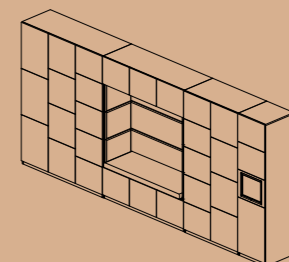

**LAYER\_LOCKER\_SET11**

Width 450  
Depth 57  
Height 205

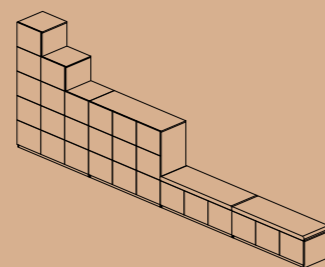

**LAYER\_LOCKER\_SET12**

Width 320  
Depth 54  
Height 205



#workspaces2024

# WORKING SPACES

01



02



# Pedestal

01  
Silver Pedestal

02  
Tin Pedestal



#workingspaces2024

# Pedestal

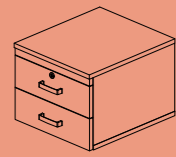

**Silver Pedestal**

Width 40  
Depth 45  
Height 32



**Silver Pedestal**

Width 40  
Depth 45  
Height 58

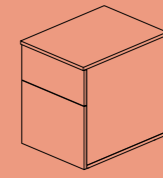

**Silver Pedestal**

Width 45  
Depth 60  
Height 60

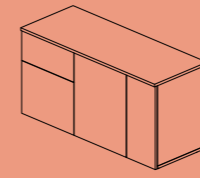

**Silver Pedestal**

Width 45  
Depth 115  
Height 60

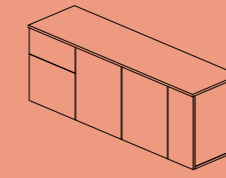

**Silver Pedestal**

Width 45  
Depth 160  
Height 60

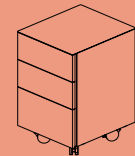

**Tin Pedestal**

Width 40  
Depth 45  
Height 61

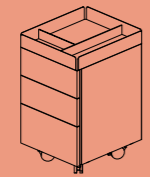

**Tin Pedestal**

Width 40  
Depth 45  
Height 68

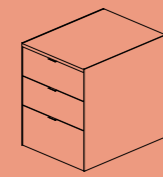

**Tin Pedestal**

Width 40  
Depth 60  
Height 60

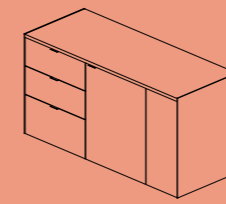

**Tin Pedestal**

Width 45  
Depth 115  
Height 60

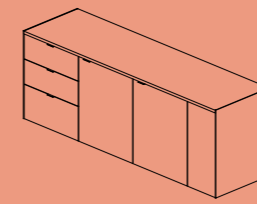

**Tin Pedestal**

Width 45  
Depth 160  
Height 60

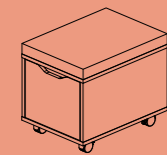

**Sydney Pedestal**

Width 50  
Depth 55  
Height 44

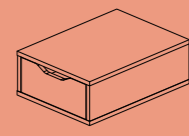

**Sydney Pedestal**

Width 45  
Depth 55  
Height 19

# WORKING SPACES



01



# Silver

01  
Silver Storage



#workingspaces2024

# Silver



**Storage\_SLV\_CAB4038H83**

Width 40  
Depth 38  
Height 83



**Storage\_SLV\_CAB4038H121**

Width 40  
Depth 38  
Height 121

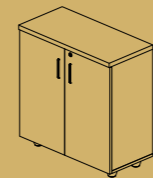

**Storage\_SLV\_CAB8038H83**

Width 80  
Depth 38  
Height 83



**Storage\_SLV\_CAB8038H121**

Width 80  
Depth 38  
Height 121

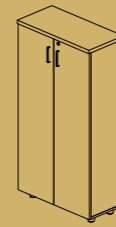

**Storage\_SLV\_CAB8038H155**

Width 80  
Depth 38  
Height 155

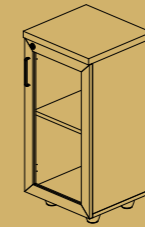

**Storage\_SLV\_CAG4038H83**

Width 40  
Depth 38  
Height 83

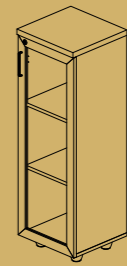

**Storage\_SLV\_CAG4038H121**

Width 40  
Depth 38  
Height 121

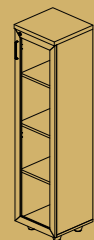

**Storage\_SLV\_CAG4038H155**

Width 40  
Depth 38  
Height 155

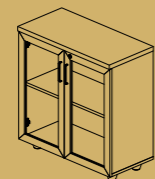

**Storage\_SLV\_CAG8038H83**

Width 80  
Depth 38  
Height 83

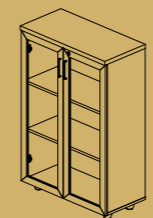

**Storage\_SLV\_CAG8038H121**

Width 80  
Depth 38  
Height 121

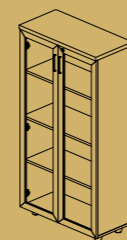

**Storage\_SLV\_CAG8038H155**

Width 80  
Depth 38  
Height 155



**Storage\_SLV\_CAB8038H191\_4C**

Width 80  
Depth 38  
Height 191



**Storage\_SLV\_CAB4038H191**

Width 40  
Depth 38  
Height 191

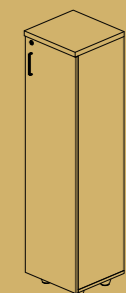

**Storage\_SLV\_CAB4038H155**

Width 40  
Depth 38  
Height 155



**Storage\_SLV\_CAB8038H191**

Width 80  
Depth 38  
Height 191

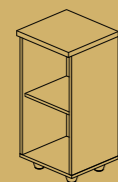

**Storage\_SLV\_CAF4038H83**

Width 40  
Depth 38  
Height 83

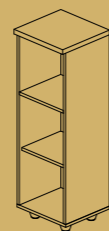

**Storage\_SLV\_CAF4038H121**

Width 40  
Depth 38  
Height 121

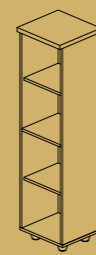

**Storage\_SLV\_CAF4038H155**

Width 40  
Depth 38  
Height 155

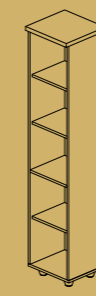

**Storage\_SLV\_CAF4038H191**

Width 40  
Depth 38  
Height 191

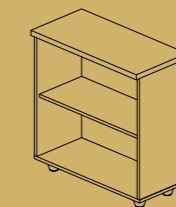

**Storage\_SLV\_CAF8038H83**

Width 80  
Depth 38  
Height 83

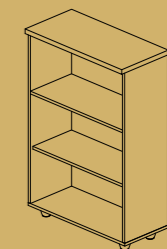

**Storage\_SLV\_CAF8038H121**

Width 80  
Depth 38  
Height 121

# Silver

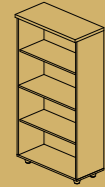

**Storage\_SLV\_CAF8038H155**

Width 80  
Depth 38  
Height 155

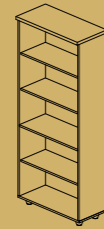

**Storage\_SLV\_CAF8038H191**

Width 80  
Depth 38  
Height 191

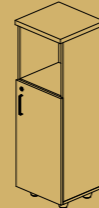

**Storage\_SLV\_CAS4038H121**

Width 40  
Depth 38  
Height 121

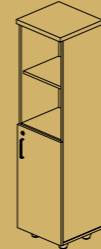

**Storage\_SLV\_CAS4038H155**

Width 40  
Depth 38  
Height 155

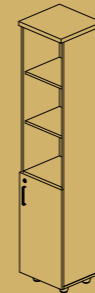

**Storage\_SLV\_CAS4038H191**

Width 40  
Depth 38  
Height 191

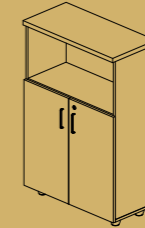

**Storage\_SLV\_CAS8038H121**

Width 80  
Depth 38  
Height 121

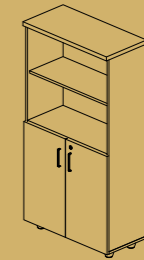

**Storage\_SLV\_CAS8038H155**

Width 80  
Depth 38  
Height 155

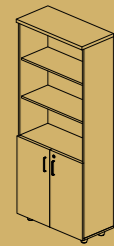

**Storage\_SLV\_CAS8038H191**

Width 80  
Depth 38  
Height 191

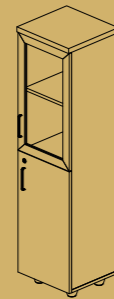

**Storage\_SLV\_CGS4038H155**

Width 40  
Depth 38  
Height 155

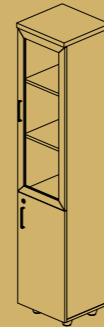

**Storage\_SLV\_CGS4038H191**

Width 40  
Depth 38  
Height 191

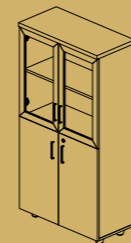

**Storage\_SLV\_CGS8038H155**

Width 80  
Depth 38  
Height 155

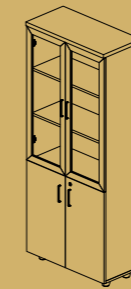

**Storage\_SLV\_CGS8038H191**

Width 80  
Depth 38  
Height 191



**Storage\_SLV\_WD8047H191**

Width 80  
Depth 47  
Height 191



**Storage\_SLV\_WD5047H191**

Width 50  
Depth 47  
Height 191

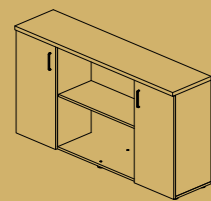

**Storage\_SLV\_CAS16040H90**

Width 160  
Depth 40  
Height 90

# WORKING SPACES



# Timy

01  
Timy Storage

02  
Timy Storage

03  
Timy Storage



#workingspaces2024

# Timy



**Desk\_Timy\_ATL\_16080\_H90**

Width 160  
Depth 80  
Height 90

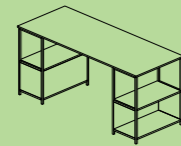

**Desk\_Timy\_ATL\_20080\_H90**

Width 200  
Depth 80  
Height 90

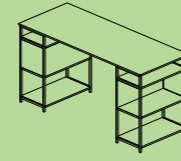

**Desk\_Timy\_ATL\_20080\_H105**

Width 200  
Depth 80  
Height 105



**Desk\_Timy\_ATL\_161080\_H105**

Width 160  
Depth 80  
Height 105

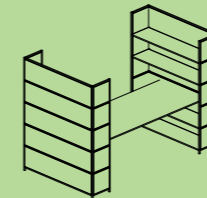

**Desk\_Timy\_UNT\_CM\_280155\_H197**

Width 280  
Depth 155  
Height 197

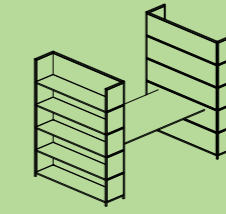

**Desk\_Timy\_UNT\_OM\_280155\_H197**

Width 280  
Depth 155  
Height 197

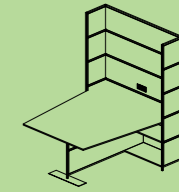

**Desk\_Timy\_UNT\_TV\_155182\_H197**

Width 155  
Depth 182  
Height 197

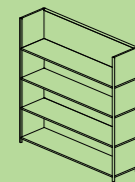

**Storage\_Timy\_SHF\_15540\_H160**

Width 155  
Depth 40  
Height 160

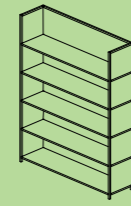

**Storage\_Timy\_SHF\_15540\_H197**

Width 155  
Depth 40  
Height 197

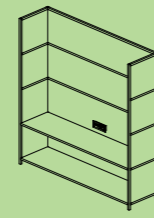

**Storage\_Timy\_UNT\_TV\_15540\_H160**

Width 155  
Depth 40  
Height 160

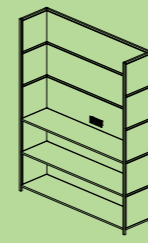

**Storage\_Timy\_UNT\_TV\_15540\_H197**

Width 155  
Depth 40  
Height 197

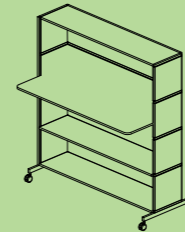

**Desk\_Timy\_MBL\_B\_H167**

Width 155  
Depth 88  
Height 167



**Desk\_Timy\_MBL\_C\_H167**

Width 155  
Depth 88  
Height 167

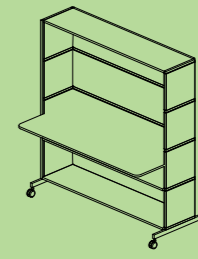

**Desk\_Timy\_MBL\_T\_H167**

Width 155  
Depth 88  
Height 167

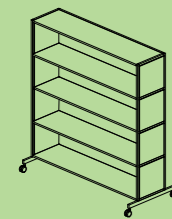

**Storage\_Timy\_MBL\_S\_H167**

Width 155  
Depth 72  
Height 167

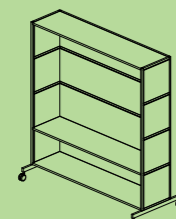

**Storage\_Timy\_MBL\_TV\_H167**

Width 155  
Depth 72  
Height 167

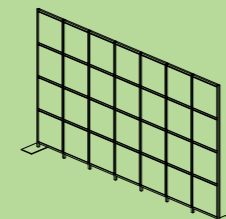

**Screen\_Timy\_270\_7X4\_H160**

Width 270  
Depth 35  
Height 160

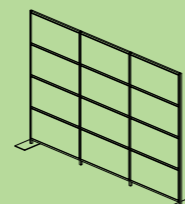

**Screen\_Timy\_230\_3X4\_H160**

Width 130  
Depth 35  
Height 160

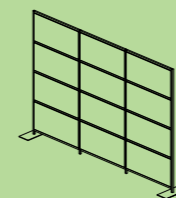

**Screen\_Timy\_190\_1X4\_H160**

Width 190  
Depth 35  
Height 160

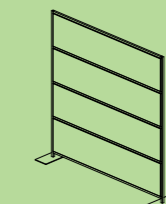

**Screen\_Timy\_155\_1X4\_H160**

Width 155  
Depth 35  
Height 160

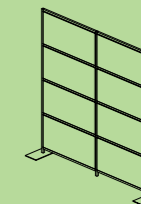

**Screen\_Timy\_155\_2X4\_H160**

Width 155  
Depth 35  
Height 160

# Timy

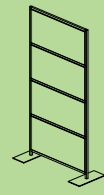

**Screen\_Timy\_78\_1X4\_H160**

Width 78  
Depth 35  
Height 160

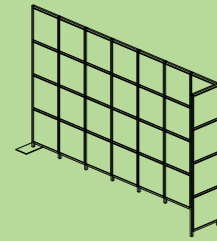

**Screen\_Timy\_270L40\_8X4\_H160**

Width 270  
Depth 40  
Height 160

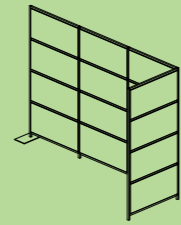

**Screen\_Timy\_230L40\_4X4\_H160**

Width 230  
Depth 40  
Height 160

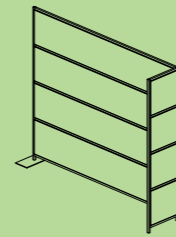

**Screen\_Timy\_190L40\_2X4\_H160**

Width 190  
Depth 40  
Height 160



**Screen\_Timy\_155L40\_3X4\_H160**

Width 155  
Depth 40  
Height 160



**Screen\_Timy\_78L40\_2X4\_H160**

Width 78  
Depth 40  
Height 160

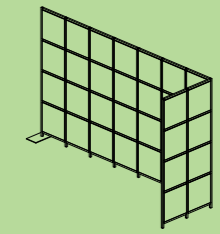

**Screen\_Timy\_270L78\_9X4\_H160**

Width 270  
Depth 78  
Height 160

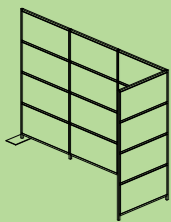

**Screen\_Timy\_230L78\_4X4\_H160**

Width 230  
Depth 78  
Height 160



**Screen\_Timy\_190L78\_2X4\_H160**

Width 190  
Depth 78  
Height 160

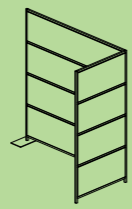

**Screen\_Timy\_155L78\_2X4\_H160**

Width 155  
Depth 78  
Height 160



**Screen\_Timy\_155L78\_3X4\_H160**

Width 155  
Depth 78  
Height 160



**Screen\_Timy\_78L78\_2X4\_H160**

Width 78  
Depth 78  
Height 160

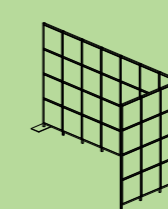

**Screen\_Timy\_270L115\_10X4\_H160**

Width 270  
Depth 115  
Height 160

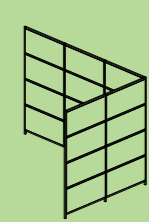

**Screen\_Timy\_230L155\_5X4\_H160**

Width 230  
Depth 155  
Height 160

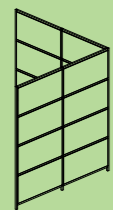

**Screen\_Timy\_190L190\_2X4\_H160**

Width 190  
Depth 190  
Height 160



**Screen\_Timy\_155L155\_2X4\_H160**

Width 155  
Depth 155  
Height 160



**Screen\_Timy\_155L155\_4X4\_H160**

Width 155  
Depth 155  
Height 160

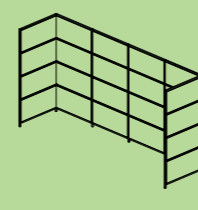

**Screen\_Timy\_305U78\_6X4\_H160**

Width 305  
Depth 78  
Height 160



**Screen\_Timy\_190U78\_3X4\_H160**

Width 190  
Depth 78  
Height 160

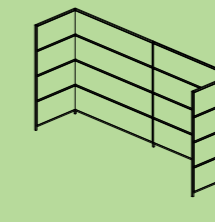

**Screen\_Timy\_305U78\_4X4\_H160**

Width 305  
Depth 78  
Height 160

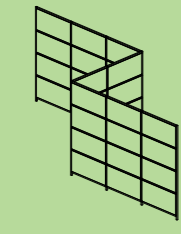

**Screen\_Timy\_460Z155\_H160**

Width 460  
Depth 155  
Height 160

# Timy

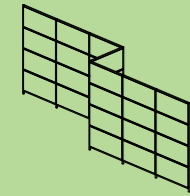

**Screen\_Timy\_460Z78\_H160**

Width 460  
Depth 78  
Height 160

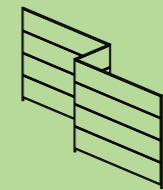

**Screen\_Timy\_382Z78\_H160**

Width 382  
Depth 78  
Height 160

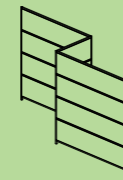

**Screen\_Timy\_305Z78\_H160**

Width 305  
Depth 78  
Height 160

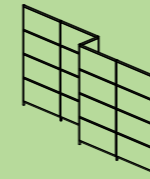

**Screen\_Timy\_305ZX40\_H160**

Width 305  
Depth 40  
Height 160



**Screen\_Timy\_155ZX305\_H160**

Width 155  
Depth 305  
Height 160



**Screen\_Timy\_155ZX230\_H160**

Width 155  
Depth 230  
Height 160



**Screen\_Timy\_155ZX155\_H160**

Width 155  
Depth 155  
Height 160

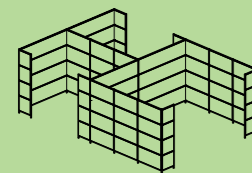

**Screen\_Timy\_ROOM\_05\_458305\_H160**

Width 458  
Depth 305  
Height 160

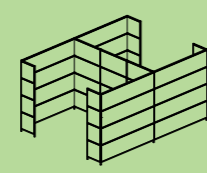

**Screen\_Timy\_ROOM\_03\_230305\_H160**

Width 230  
Depth 305  
Height 160

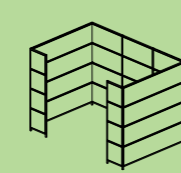

**Screen\_Timy\_ROOM\_01\_230155\_H160**

Width 230  
Depth 155  
Height 160

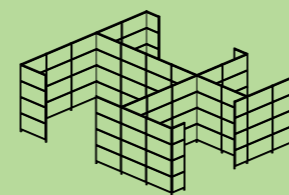

**Screen\_Timy\_ROOM\_06\_458382\_H160**

Width 458  
Depth 382  
Height 160

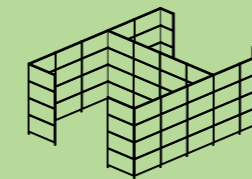

**Screen\_Timy\_ROOM\_04\_305382\_H160**

Width 305  
Depth 382  
Height 160

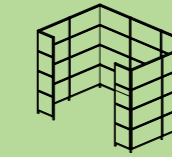

**Screen\_Timy\_ROOM\_02\_230155\_H160**

Width 230  
Depth 155  
Height 160

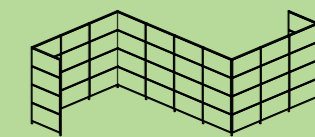

**Screen\_Timy\_ROOM\_08\_305X458\_H160**

Width 305  
Depth 458  
Height 160

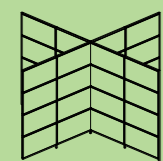

**Screen\_Timy\_ROOM\_07\_305X305\_H160**

Width 305  
Depth 305  
Height 160

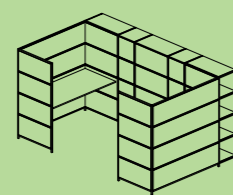

**Desk\_Timy\_BTH\_W\_1P\_ISOF\_305190\_H160**

Width 305  
Depth 190  
Height 160

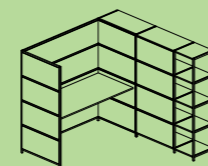

**Desk\_Timy\_BTH\_W\_1P\_190190\_H160**

Width 190  
Depth 190  
Height 160

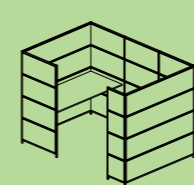

**Desk\_Timy\_BTH\_W\_1P\_230155\_H160**

Width 230  
Depth 155  
Height 160

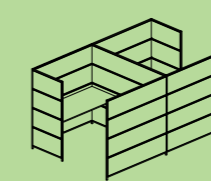

**Desk\_Timy\_BTH\_W\_2P\_190306\_H160**

Width 190  
Depth 306  
Height 160

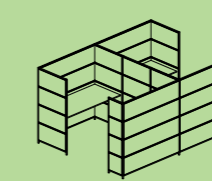

**Desk\_Timy\_BTH\_W\_2P\_230306\_H160**

Width 230  
Depth 306  
Height 160

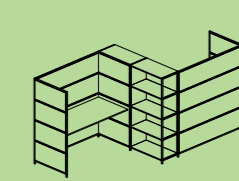

**Desk\_Timy\_BTH\_W\_2P\_345155\_H160**

Width 345  
Depth 155  
Height 160

# Timy

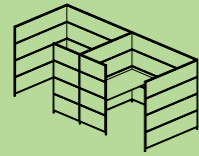

**Desk\_Timy\_BTH\_W\_2P\_380155\_H160**

Width 380  
Depth 155  
Height 160

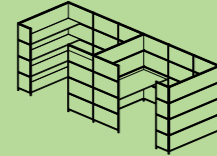

**Desk\_Timy\_BTH\_W\_2P\_460155\_H160**

Width 460  
Depth 155  
Height 160

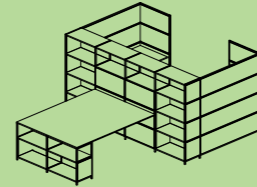

**Desk\_Timy\_BTH\_W\_2P\_M\_305390\_H160**

Width 305  
Depth 390  
Height 160

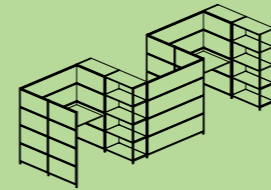

**Desk\_Timy\_BTH\_W\_3P\_535155\_H160**

Width 535  
Depth 155  
Height 160

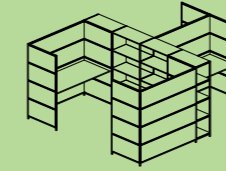

**Desk\_Timy\_BTH\_W\_4P\_345305\_H160**

Width 345  
Depth 305  
Height 160

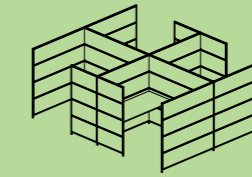

**Desk\_Timy\_BTH\_W\_4P\_380106\_H160**

Width 380  
Depth 106  
Height 160

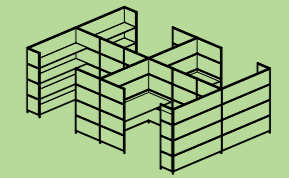

**Desk\_Timy\_BTH\_W\_4P\_460306\_H160**

Width 460  
Depth 306  
Height 160

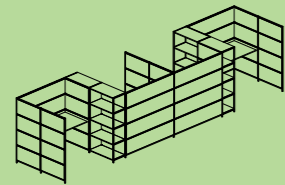

**Desk\_Timy\_BTH\_W\_4P\_685155\_H160**

Width 685  
Depth 155  
Height 160

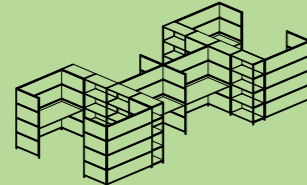

**Desk\_Timy\_BTH\_W\_8P\_685305\_H160**

Width 685  
Depth 305  
Height 160

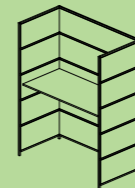

**Desk\_Timy\_B\_15578\_H197**

Width 155  
Depth 78  
Height 197

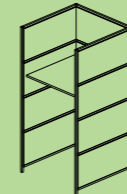

**Desk\_Timy\_BTH\_B\_7878\_H160**

Width 78  
Depth 78  
Height 160

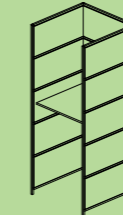

**Desk\_Timy\_BTH\_B\_7878\_H197**

Width 78  
Depth 78  
Height 197

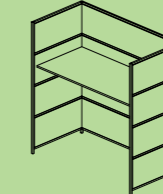

**Desk\_Timy\_BTH\_B\_15578\_H160**

Width 155  
Depth 78  
Height 160

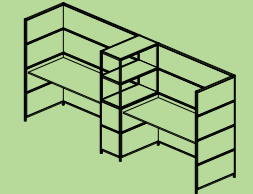

**Desk\_Timy\_BTH\_W\_2P\_34578\_H160**

Width 345  
Depth 78  
Height 160

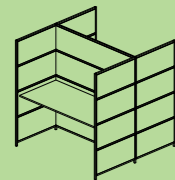

**Desk\_Timy\_BTH\_W\_2P\_155155\_H160**

Width 155  
Depth 155  
Height 160



**Desk\_Timy\_BTH\_W\_2P\_155155\_H197**

Width 155  
Depth 155  
Height 197

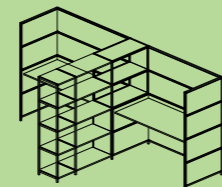

**Desk\_Timy\_BTH\_W\_2P\_345192\_H160**

Width 345  
Depth 192  
Height 160

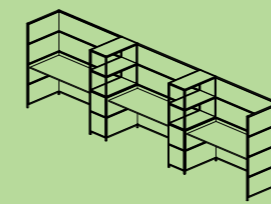

**Desk\_Timy\_BTH\_W\_3P\_53578\_H160**

Width 535  
Depth 78  
Height 160

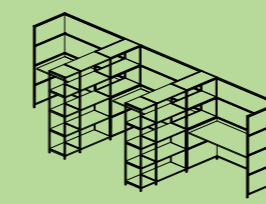

**Desk\_Timy\_BTH\_W\_3P\_535192\_H160**

Width 535  
Depth 192  
Height 160

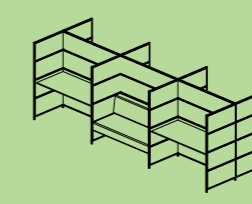

**Desk\_Timy\_BTH\_W\_4P\_2SOF\_460155\_H160**

Width 460  
Depth 155  
Height 160

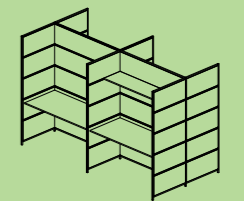

**Desk\_Timy\_BTH\_W\_4P\_306155\_H197**

Width 306  
Depth 155  
Height 197

# Timy

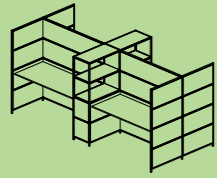

**Desk\_Timy\_BTH\_W\_4P\_345155\_H160**

Width 345  
Depth 155  
Height 160

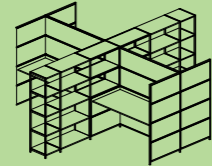

**Desk\_Timy\_BTH\_W\_4P\_345380\_H160**

Width 345  
Depth 380  
Height 160

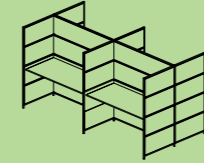

**Desk\_Timy\_BTH\_W\_4P\_306155\_H160**

Width 306  
Depth 155  
Height 160

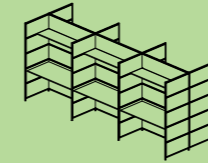

**Desk\_Timy\_BTH\_W\_6P\_460155\_H197**

Width 460  
Depth 155  
Height 197

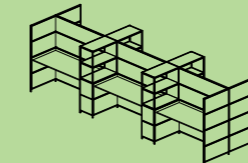

**Desk\_Timy\_BTH\_W\_6P\_535155\_H160**

Width 535  
Depth 155  
Height 160



**Desk\_Timy\_BTH\_W\_7878\_H160**

Width 78  
Depth 78  
Height 160



**Desk\_Timy\_BTH\_W\_7878\_H197**

Width 78  
Depth 78  
Height 197

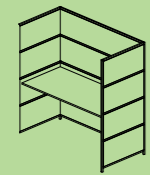

**Desk\_Timy\_BTH\_W\_15578\_H160**

Width 155  
Depth 78  
Height 160

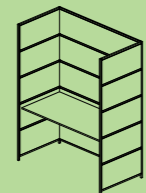

**Desk\_Timy\_BTH\_W\_15578\_H197**

Width 155  
Depth 78  
Height 197

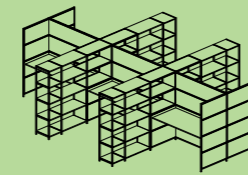

**Desk\_Timy\_BTH\_W\_6P\_535380\_H160**

Width 535  
Depth 380  
Height 160



**Seating\_Timy\_SOF\_15578\_H160**

Width 155  
Depth 78  
Height 160

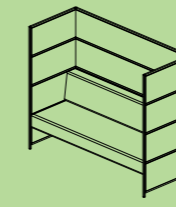

**Seating\_Timy\_SOF\_19078\_H160**

Width 190  
Depth 78  
Height 160

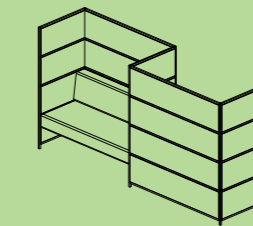

**Seating\_Timy\_SOF\_30578\_H160**

Width 305  
Depth 78  
Height 160

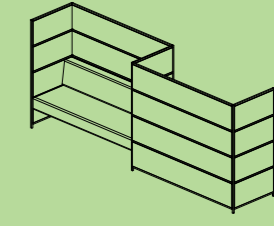

**Seating\_Timy\_SOF\_38078\_H160**

Width 380  
Depth 78  
Height 160

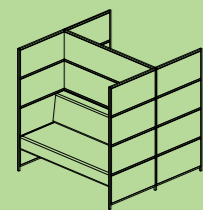

**Seating\_Timy\_SOF\_155155\_H160**

Width 155  
Depth 155  
Height 160

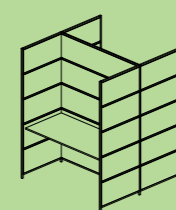

**Seating\_Timy\_SOF\_190155\_H160**

Width 190  
Depth 155  
Height 160

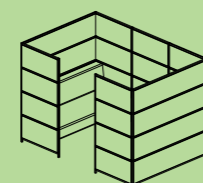

**Seating\_Timy\_SOF\_230155\_H160**

Width 230  
Depth 155  
Height 160

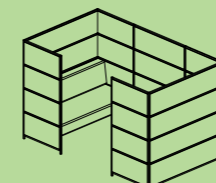

**Seating\_Timy\_SOF\_260155\_H160**

Width 260  
Depth 155  
Height 160

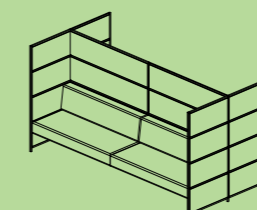

**Seating\_Timy\_SOF\_305155\_H160**

Width 305  
Depth 155  
Height 160

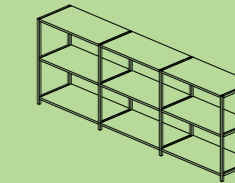

**Timy\_SET 1**

Width 234  
Depth 40  
Height 83

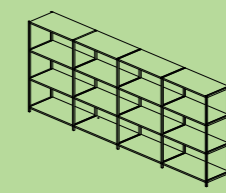

**Timy\_SET 2**

Width 312  
Depth 40  
Height 120

# Timy

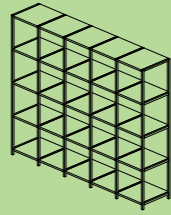

**Timy\_SET 3**

Width 200  
Depth 40  
Height 160

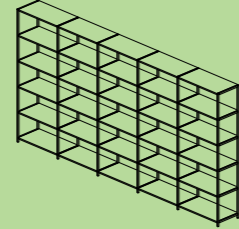

**Timy\_SET 4**

Width 390  
Depth 40  
Height 197

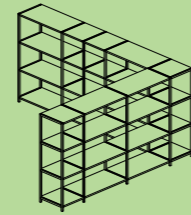

**Timy\_SET 5**

Width 276  
Depth 236  
Height 120

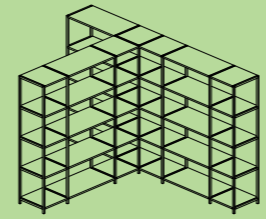

**Timy\_SET 6**

Width 276  
Depth 198  
Height 160

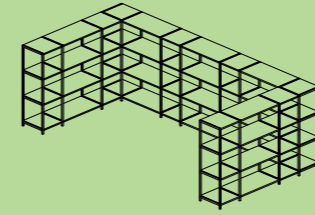

**Timy\_SET 7**

Width 394  
Depth 198  
Height 120

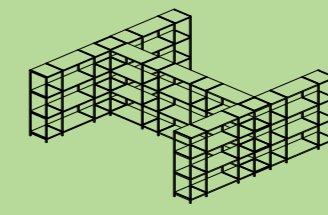

**Timy\_SET 8**

Width 394  
Depth 356  
Height 120

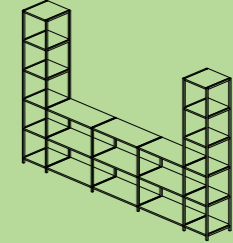

**Timy\_SET 9**

Width 314  
Depth 40  
Height 197

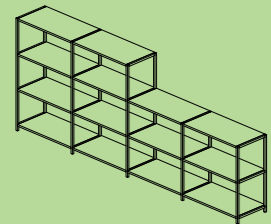

**Timy\_SET 10**

Width 312  
Depth 40  
Height 120

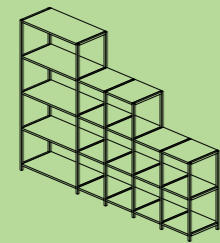

**Timy\_SET 11**

Width 238  
Depth 40  
Height 160

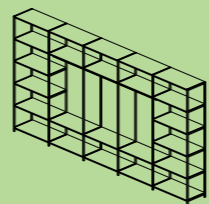

**Timy\_SET 12**

Width 390  
Depth 40  
Height 197

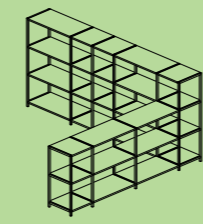

**Timy\_SET 13**

Width 276  
Depth 236  
Height 120

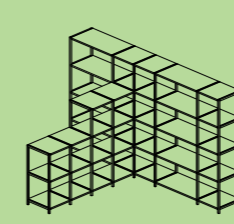

**Timy\_SET 14**

Width 276  
Depth 200  
Height 160

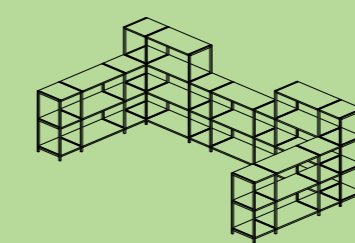

**Timy\_SET 15**

Width 394  
Depth 198  
Height 120

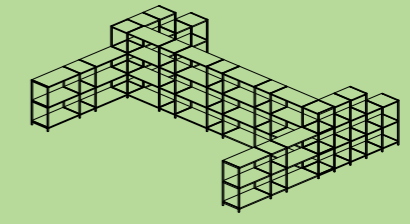

**Timy\_SET 16**

Width 512  
Depth 396  
Height 120

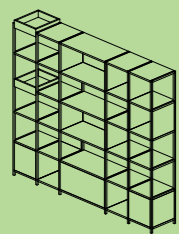

**Storage\_Timy\_CONFIGURATION\_SET1**

Width 230  
Depth 40  
Height 160

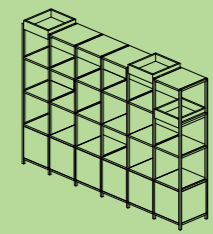

**Storage\_Timy\_CONFIGURATION\_SET2**

Width 230  
Depth 40  
Height 160

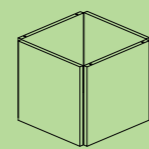

**Storage\_Timy\_CAB\_4040**

Width 40  
Depth 40  
Height 35

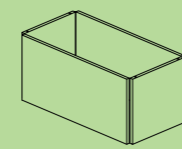

**Storage\_Timy\_CAB\_7840**

Width 78  
Depth 40  
Height 35

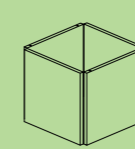

**Storage\_Timy\_DRW\_4040**

Width 40  
Depth 40  
Height 35

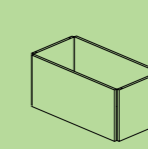

**Storage\_Timy\_DRW\_7840**

Width 78  
Depth 40  
Height 35

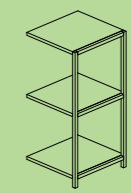

**Storage\_Timy\_EXT40\_H83**

Width 40  
Depth 40  
Height 83

# Timy

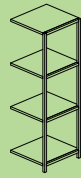

**Storage\_Timy\_EXT40\_H120**

Width 40  
Depth 40  
Height 120



**Storage\_Timy\_EXT40\_H160**

Width 40  
Depth 40  
Height 160



**Storage\_Timy\_EXT40\_H197**

Width 40  
Depth 40  
Height 197

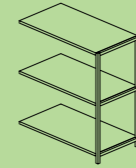

**Storage\_Timy\_EXT78\_H83**

Width 78  
Depth 40  
Height 83

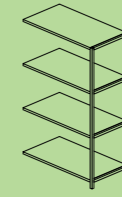

**Storage\_Timy\_EXT78\_H120**

Width 78  
Depth 40  
Height 120



**Storage\_Timy\_EXT78\_H160**

Width 78  
Depth 40  
Height 160



**Storage\_Timy\_EXT78\_H197**

Width 78  
Depth 40  
Height 197



**Storage\_Timy\_LCB40\_H83**

Width 40  
Depth 40  
Height 83



**Storage\_Timy\_LCB40\_H120**

Width 40  
Depth 40  
Height 120



**Storage\_Timy\_LCB40\_H160**

Width 40  
Depth 40  
Height 160



**Storage\_Timy\_LCB40\_H197**

Width 40  
Depth 40  
Height 197



**Storage\_Timy\_LCF40\_H83**

Width 40  
Depth 40  
Height 83



**Storage\_Timy\_LCF40\_H120**

Width 40  
Depth 40  
Height 120



**Storage\_Timy\_LCF40\_H160**

Width 40  
Depth 40  
Height 160

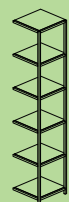

**Storage\_Timy\_LCF40\_H197**

Width 40  
Depth 40  
Height 197

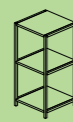

**Storage\_Timy\_MDL40\_H83**

Width 40  
Depth 40  
Height 83



**Storage\_Timy\_MDL40\_H120**

Width 40  
Depth 40  
Height 120



**Storage\_Timy\_MDL40\_H160**

Width 40  
Depth 40  
Height 160



**Storage\_Timy\_MDL40\_H197**

Width 40  
Depth 40  
Height 197

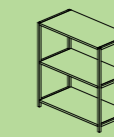

**Storage\_Timy\_MDL78\_H83**

Width 78  
Depth 40  
Height 83

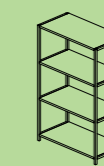

**Storage\_Timy\_MDL78\_H120**

Width 78  
Depth 40  
Height 120

# Timy

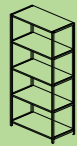

**Storage\_Timy\_MDL78\_H160**

Width 78  
Depth 40  
Height 160



**Storage\_Timy\_MDL78\_H197**

Width 78  
Depth 40  
Height 197



**Storage\_Timy\_PNF\_40**

Width 40  
Depth 3  
Height 35

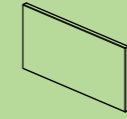

**Storage\_Timy\_PNF78**

Width 78  
Depth 3  
Height 35



**Storage\_Timy\_PNL\_40**

Width 40  
Depth 1,8  
Height 35

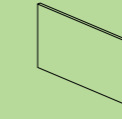

**Storage\_Timy\_PNL\_78**

Width 40  
Depth 1,8  
Height 35

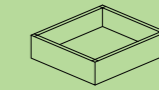

**Storage\_Timy\_PNT\_4040**

Width 40  
Depth 40  
Height 10

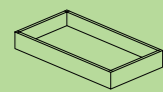

**Storage\_Timy\_PNT\_7840**

Width 78  
Depth 40  
Height 10



**Storage\_Timy\_SPF\_40**

Width 3  
Depth 40  
Height 35

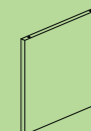

**Storage\_Timy\_SPN\_40**

Width 1,8  
Depth 40  
Height 35



**Storage\_Timy\_TCE40\_H83**

Width 40  
Depth 40  
Height 83



**Storage\_Timy\_TCE40\_H120**

Width 40  
Depth 40  
Height 120



**Storage\_Timy\_TCE40\_H160**

Width 40  
Depth 40  
Height 160



**Storage\_Timy\_TCE40\_H197**

Width 40  
Depth 40  
Height 197

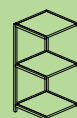

**Storage\_Timy\_TCS40\_H83**

Width 40  
Depth 40  
Height 83



**Storage\_Timy\_TCS40\_H120**

Width 40  
Depth 40  
Height 120



**Storage\_Timy\_TCS40\_H160**

Width 40  
Depth 40  
Height 160

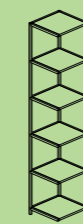

**Storage\_Timy\_TCS40\_H197**

Width 40  
Depth 40  
Height 197

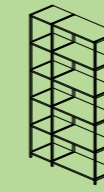

**Storage\_Timy\_SET4078\_Mixed1**

Width 118  
Depth 40  
Height 197

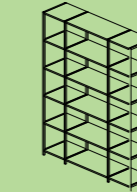

**Storage\_Timy\_SET4078\_Mixed2**

Width 156  
Depth 40  
Height 197

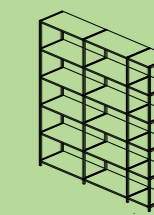

**Storage\_Timy\_SET4078\_Mixed3**

Width 196  
Depth 40  
Height 197

# Timy

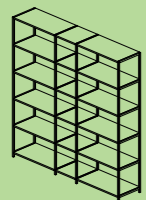

**Stroge\_Timy\_SET4078\_Mixed4**

Width 194  
Depth 40  
Height 197

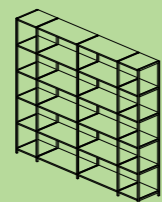

**Stroge\_Timy\_SET4078\_Mixed5**

Width 234  
Depth 40  
Height 197

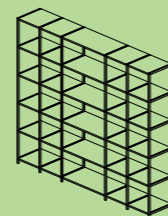

**Stroge\_Timy\_SET4078\_Mixed6**

Width 232  
Depth 40  
Height 197

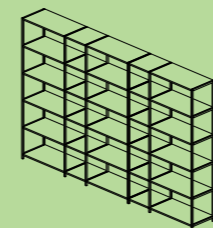

**Stroge\_Timy\_SET4078\_Mixed7**

Width 310  
Depth 40  
Height 197

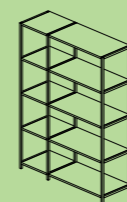

**Stroge\_Timy\_SET4078\_Mixed8**

Width 118  
Depth 40  
Height 160

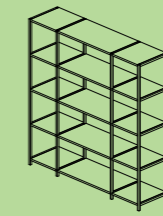

**Stroge\_Timy\_SET4078\_Mixed9**

Width 156  
Depth 40  
Height 160

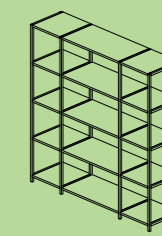

**Stroge\_Timy\_SET4078\_Mixed10**

Width 156  
Depth 40  
Height 160

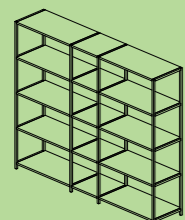

**Stroge\_Timy\_SET4078\_Mixed11**

Width 194  
Depth 40  
Height 160

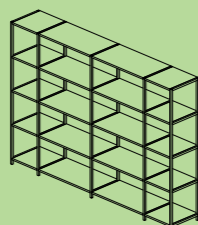

**Stroge\_Timy\_SET4078\_Mixed12**

Width 234  
Depth 40  
Height 160

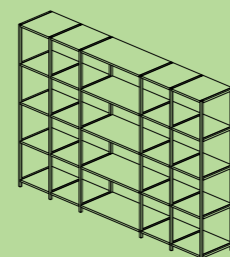

**Stroge\_Timy\_SET4078\_Mixed13**

Width 232  
Depth 40  
Height 160

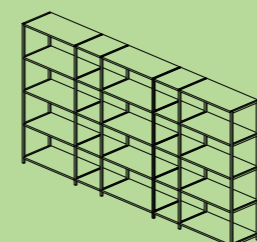

**Stroge\_Timy\_SET4078\_Mixed14**

Width 310  
Depth 40  
Height 160

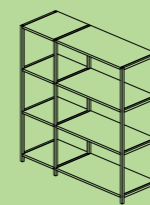

**Stroge\_Timy\_SET4078\_Mixed15**

Width 118  
Depth 40  
Height 120

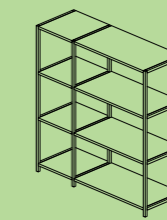

**Stroge\_Timy\_SET4078\_Mixed16**

Width 118  
Depth 40  
Height 120

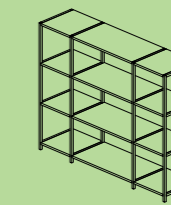

**Stroge\_Timy\_SET4078\_Mixed17**

Width 156  
Depth 40  
Height 120

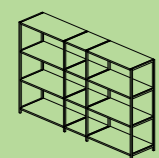

**Stroge\_Timy\_SET4078\_Mixed18**

Width 194  
Depth 40  
Height 120

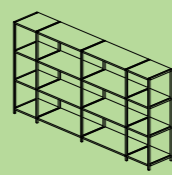

**Stroge\_Timy\_SET4078\_Mixed19**

Width 234  
Depth 40  
Height 120

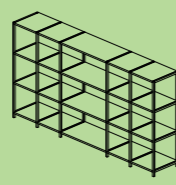

**Stroge\_Timy\_SET4078\_Mixed20**

Width 232  
Depth 40  
Height 120

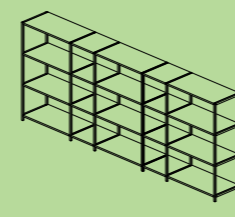

**Stroge\_Timy\_SET4078\_Mixed21**

Width 310  
Depth 40  
Height 120

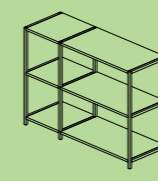

**Stroge\_Timy\_SET4078\_Mixed22**

Width 118  
Depth 40  
Height 83

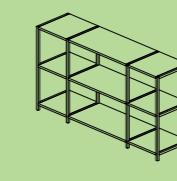

**Stroge\_Timy\_SET4078\_Mixed23**

Width 156  
Depth 40  
Height 83

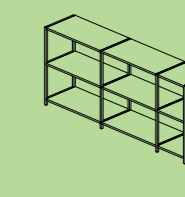

**Stroge\_Timy\_SET4078\_Mixed24**

Width 194  
Depth 40  
Height 83

# Timy

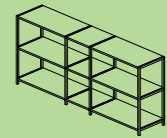

**Stroge\_Timy\_SET4078\_Mixed25**

Width 194  
Depth 40  
Height 83

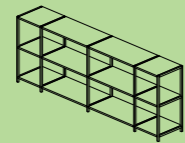

**Stroge\_Timy\_SET4078\_Mixed26**

Width 234  
Depth 40  
Height 83

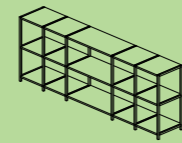

**Stroge\_Timy\_SET4078\_Mixed27**

Width 232  
Depth 40  
Height 83

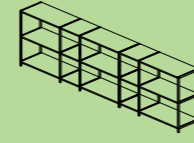

**Stroge\_Timy\_SET4078\_Mixed28**

Width 310  
Depth 40  
Height 83



**Storage\_Timy\_MDL4040\_Set1**

Width 78  
Depth 40  
Height 197

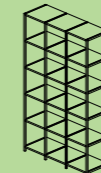

**Storage\_Timy\_MDL4040\_Set2**

Width 116  
Depth 40  
Height 197

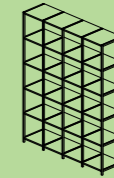

**Storage\_Timy\_MDL4040\_Set3**

Width 154  
Depth 40  
Height 197

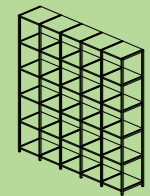

**Storage\_Timy\_MDL4040\_Set4**

Width 192  
Depth 40  
Height 197

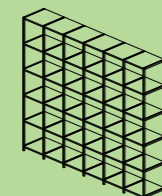

**Storage\_Timy\_MDL4040\_Set5**

Width 230  
Depth 40  
Height 197



**Storage\_Timy\_MDL4040\_Set6**

Width 78  
Depth 40  
Height 160

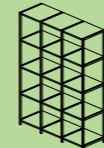

**Storage\_Timy\_MDL4040\_Set7**

Width 116  
Depth 40  
Height 160



**Storage\_Timy\_MDL4040\_Set8**

Width 154  
Depth 40  
Height 160

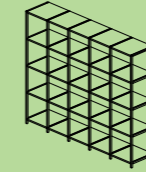

**Storage\_Timy\_MDL4040\_Set9**

Width 192  
Depth 40  
Height 160

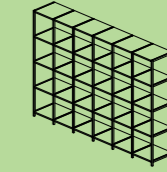

**Storage\_Timy\_MDL4040\_Set10**

Width 230  
Depth 40  
Height 160



**Storage\_Timy\_MDL4040\_Set11**

Width 78  
Depth 40  
Height 120



**Storage\_Timy\_MDL4040\_Set12**

Width 116  
Depth 40  
Height 120



**Storage\_Timy\_MDL4040\_Set13**

Width 154  
Depth 40  
Height 120

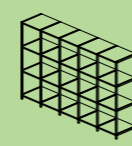

**Storage\_Timy\_MDL4040\_Set14**

Width 192  
Depth 40  
Height 120

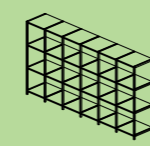

**Storage\_Timy\_MDL4040\_Set15**

Width 230  
Depth 40  
Height 120



**Storage\_Timy\_MDL4040\_Set16**

Width 78  
Depth 40  
Height 83



**Storage\_Timy\_MDL4040\_Set17**

Width 116  
Depth 40  
Height 83

# Timy

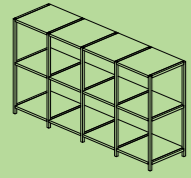

**Storage\_Timy\_MDL4040\_Set18**

Width 154  
Depth 40  
Height 83

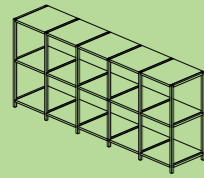

**Storage\_Timy\_MDL4040\_Set19**

Width 192  
Depth 40  
Height 83

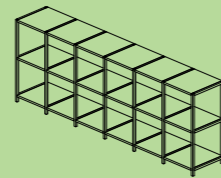

**Storage\_Timy\_MDL4040\_Set20**

Width 230  
Depth 40  
Height 83

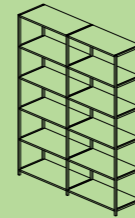

**Storage\_Timy\_MDL7878\_Set1**

Width 154  
Depth 40  
Height 197

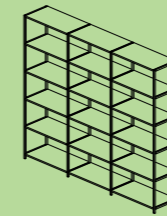

**Storage\_Timy\_MDL7878\_Set2**

Width 230  
Depth 40  
Height 197

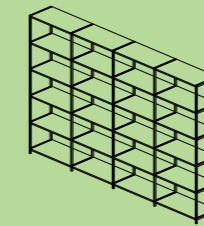

**Storage\_Timy\_MDL7878\_Set3**

Width 306  
Depth 40  
Height 197

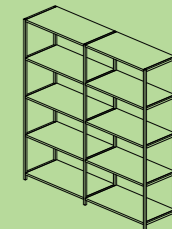

**Storage\_Timy\_MDL7878\_Set4**

Width 154  
Depth 40  
Height 160

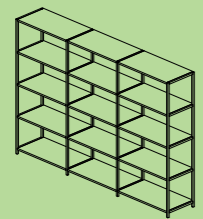

**Storage\_Timy\_MDL7878\_Set5**

Width 230  
Depth 40  
Height 160

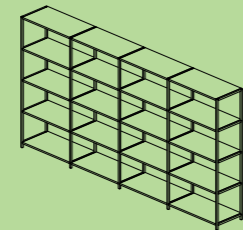

**Storage\_Timy\_MDL7878\_Set6**

Width 306  
Depth 40  
Height 160

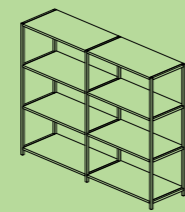

**Storage\_Timy\_MDL7878\_Set7**

Width 154  
Depth 40  
Height 120

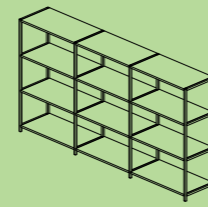

**Storage\_Timy\_MDL7878\_Set8**

Width 230  
Depth 40  
Height 120

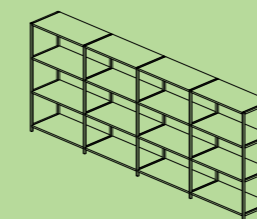

**Storage\_Timy\_MDL7878\_Set9**

Width 306  
Depth 40  
Height 120

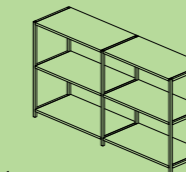

**Storage\_Timy\_MDL7878\_Set10**

Width 154  
Depth 40  
Height 83

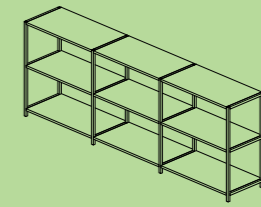

**Storage\_Timy\_MDL7878\_Set11**

Width 230  
Depth 40  
Height 83

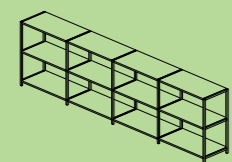

**Storage\_Timy\_MDL7878\_Set12**

Width 306  
Depth 40  
Height 83



**Storage\_Timy\_VES\_40\_H160**

Width 40  
Depth 40  
Height 160



**Storage\_Timy\_VES\_40\_H197**

Width 40  
Depth 40  
Height 197

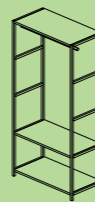

**Storage\_Timy\_VES\_78\_H160**

Width 78  
Depth 40  
Height 160



**Storage\_Timy\_VES\_78\_H197**

Width 78  
Depth 40  
Height 197



**Storage\_Timy\_VES\_155U40\_H197**

Width 155  
Depth 40  
Height 197

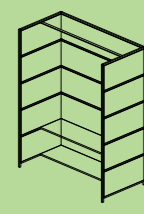

**Storage\_Timy\_VES\_155U78\_H197**

Width 155  
Depth 78  
Height 197

# Timy

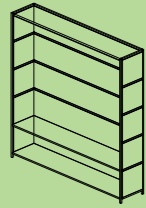

**Storage\_Timy\_VES\_190U40\_H197**

Width 190  
Depth 40  
Height 197

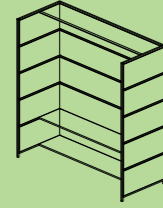

**Storage\_Timy\_VES\_190U78\_H197**

Width 190  
Depth 78  
Height 197

# WORKING SPACES

01



02

# Tin

01  
Tin Storage

02  
Tin Storage



#workingspaces2024

# Tin

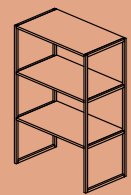

**Storage\_TIN\_ACS8045H120**

Width 80  
Depth 45  
Height 120

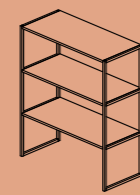

**Storage\_TIN\_ACS10045H120**

Width 100  
Depth 45  
Height 120

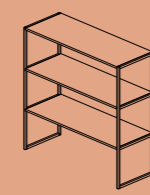

**Storage\_TIN\_ACS12045H120**

Width 120  
Depth 45  
Height 120

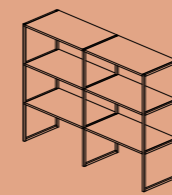

**Storage\_TIN\_ACS16045H120**

Width 160  
Depth 45  
Height 120

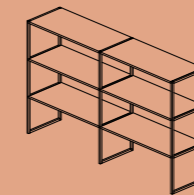

**Storage\_TIN\_ACS20045H120**

Width 200  
Depth 45  
Height 120

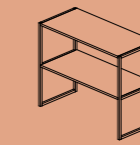

**Storage\_TIN\_ACS10045H80**

Width 100  
Depth 45  
Height 80

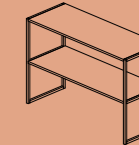

**Storage\_TIN\_ACS12045H80**

Width 120  
Depth 45  
Height 80

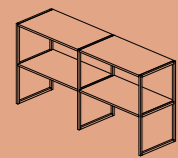

**Storage\_TIN\_ACS16045H80**

Width 160  
Depth 45  
Height 80

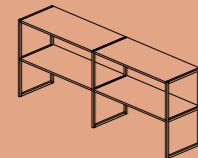

**Storage\_TIN\_ACS20045H80**

Width 200  
Depth 45  
Height 80

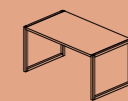

**Storage\_TIN\_ACS8045H40**

Width 80  
Depth 45  
Height 40

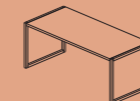

**Storage\_TIN\_ACS10045H40**

Width 100  
Depth 45  
Height 40

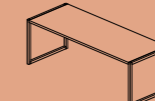

**Storage\_TIN\_ACS12045H40**

Width 120  
Depth 45  
Height 40

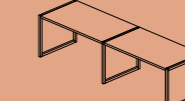

**Storage\_TIN\_ACS16045H40**

Width 160  
Depth 45  
Height 40

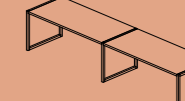

**Storage\_TIN\_ACS20045H40**

Width 200  
Depth 45  
Height 40

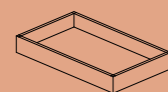

**Storage\_TIN\_ACP7545H10**

Width 75  
Depth 45  
Height 10

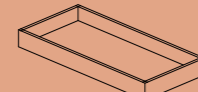

**Storage\_TIN\_ACP9545H10**

Width 95  
Depth 45  
Height 10

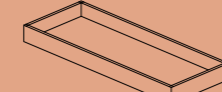

**Storage\_TIN\_ACP13545H10**

Width 135  
Depth 45  
Height 10

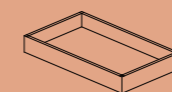

**Storage\_TIN\_ACP7645H10**

Width 76  
Depth 45  
Height 10

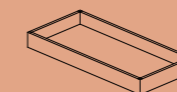

**Storage\_TIN\_ACP9645H10**

Width 96  
Depth 45  
Height 10

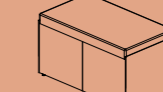

**Storage\_TIN\_BNC8045H45**

Width 80  
Depth 45  
Height 45

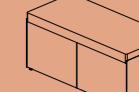

**Storage\_TIN\_BNC10045H45**

Width 100  
Depth 45  
Height 45

# Tin

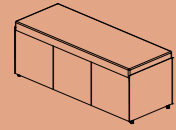

**Storage\_TIN\_BNC12045H45**

Width 120  
Depth 45  
Height 45

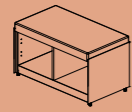

**Storage\_TIN\_BNO8045H45**

Width 80  
Depth 45  
Height 45

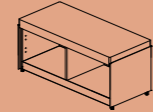

**Storage\_TIN\_BNO10045H45**

Width 100  
Depth 45  
Height 45

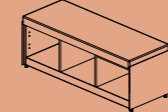

**Storage\_TIN\_BNO12045H45**

Width 120  
Depth 45  
Height 45

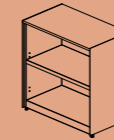

**Storage\_TIN\_CAF8045H80**

Width 80  
Depth 45  
Height 80

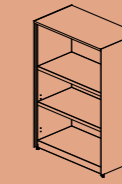

**Storage\_TIN\_CAF8045H120**

Width 80  
Depth 45  
Height 120

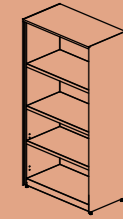

**Storage\_TIN\_CAF8045H160**

Width 80  
Depth 45  
Height 160

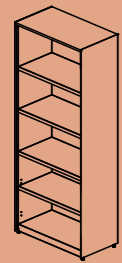

**Storage\_TIN\_CAF8045H200**

Width 80  
Depth 45  
Height 200

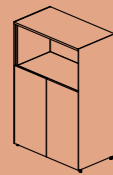

**Storage\_TIN\_CAS8045H120**

Width 80  
Depth 45  
Height 120

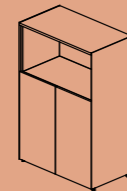

**Storage\_TIN\_CAS8045H160**

Width 80  
Depth 45  
Height 160

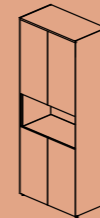

**Storage\_TIN\_CAM8045H160**

Width 80  
Depth 45  
Height 160

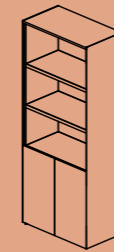

**Storage\_TIN\_CAS8045H200**

Width 80  
Depth 45  
Height 200

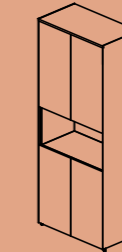

**Storage\_TIN\_CAM8045H200**

Width 80  
Depth 45  
Height 200

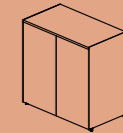

**Storage\_TIN\_CAB8045H80**

Width 80  
Depth 45  
Height 80

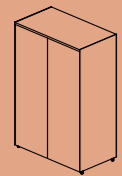

**Storage\_TIN\_CAB8045H120**

Width 80  
Depth 45  
Height 120

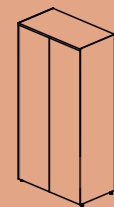

**Storage\_TIN\_CAB8045H160**

Width 80  
Depth 45  
Height 160

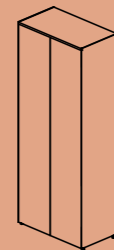

**Storage\_TIN\_CAB8045H200**

Width 80  
Depth 45  
Height 200

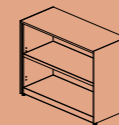

**Storage\_TIN\_CAF10045H80**

Width 100  
Depth 45  
Height 80

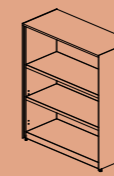

**Storage\_TIN\_CAF10045H120**

Width 100  
Depth 45  
Height 120

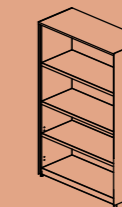

**Storage\_TIN\_CAF10045H160**

Width 100  
Depth 45  
Height 160

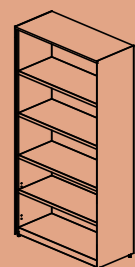

**Storage\_TIN\_CAF10045H200**

Width 100  
Depth 45  
Height 200

# Tin

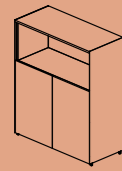

**Storage\_TIN\_CAS10045H120**

Width 100  
Depth 45  
Height 120

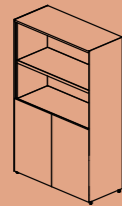

**Storage\_TIN\_CAS10045H160**

Width 100  
Depth 45  
Height 160

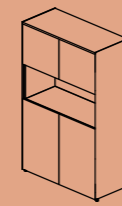

**Storage\_TIN\_CAM10045H160**

Width 100  
Depth 45  
Height 160

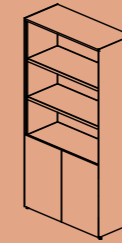

**Storage\_TIN\_CAS10045H200**

Width 100  
Depth 45  
Height 200

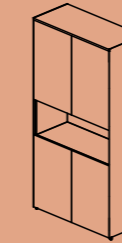

**Storage\_TIN\_CAM10045H200**

Width 100  
Depth 45  
Height 200

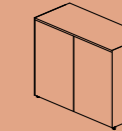

**Storage\_TIN\_CAB10045H80**

Width 100  
Depth 45  
Height 80

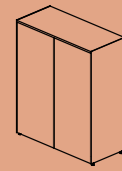

**Storage\_TIN\_CAB10045H120**

Width 100  
Depth 45  
Height 120

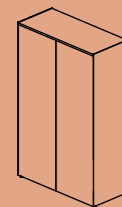

**Storage\_TIN\_CAB10045H160**

Width 100  
Depth 45  
Height 160

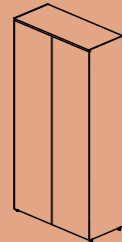

**Storage\_TIN\_CAB10045H200**

Width 100  
Depth 45  
Height 200

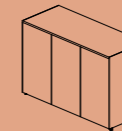

**Storage\_TIN\_CNS12050H80**

Width 100  
Depth 50  
Height 80

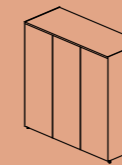

**Storage\_TIN\_CNS12050H120**

Width 120  
Depth 50  
Height 120

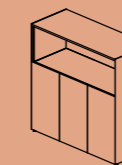

**Storage\_TIN\_CNO12050H120**

Width 120  
Depth 50  
Height 120

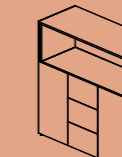

**Storage\_TIN\_CND12050H120**

Width 120  
Depth 50  
Height 120

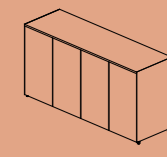

**Storage\_TIN\_CNS16050H80**

Width 160  
Depth 50  
Height 80

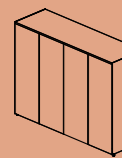

**Storage\_TIN\_CNS16050H120**

Width 160  
Depth 50  
Height 120

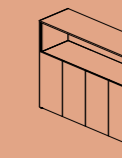

**Storage\_TIN\_CNO16050H120**

Width 160  
Depth 50  
Height 120

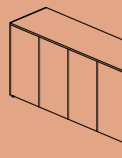

**Storage\_TIN\_CNS20050H80**

Width 200  
Depth 50  
Height 80

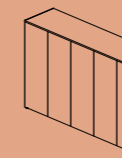

**Storage\_TIN\_CAF10045H80**

Width 100  
Depth 45  
Height 80

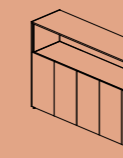

**Storage\_TIN\_CNO20050H120**

Width 200  
Depth 50  
Height 120

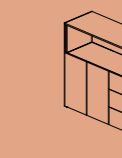

**Storage\_TIN\_CND20050H120**

Width 200  
Depth 20  
Height 120

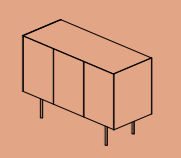

**Storage\_TIN\_CNL12050H80**

Width 120  
Depth 50  
Height 80

# Tin

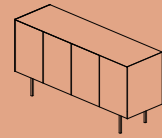

**Storage\_TIN\_CNL16050H80**

Width 160  
Depth 50  
Height 80

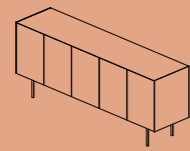

**Storage\_TIN\_CNL20050H80**

Width 200  
Depth 50  
Height 80



**Storage\_TIN\_CON4045H61**

Width 40  
Depth 45  
Height 61

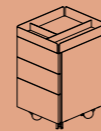

**Storage\_TIN\_COT4045H68**

Width 40  
Depth 45  
Height 68

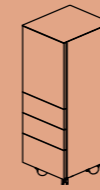

**Storage\_TIN\_CON4045H110**

Width 40  
Depth 45  
Height 110

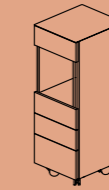

**Storage\_TIN\_COS4045H110**

Width 40  
Depth 45  
Height 110

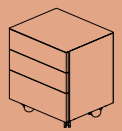

**Storage\_TIN\_CON5545H61**

Width 55  
Depth 45  
Height 61

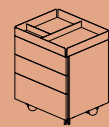

**Storage\_TIN\_COT5545H68**

Width 55  
Depth 45  
Height 68

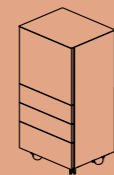

**Storage\_TIN\_CON5545H110**

Width 55  
Depth 45  
Height 110

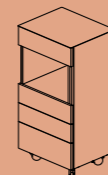

**Storage\_TIN\_COS5545H110**

Width 55  
Depth 45  
Height 110

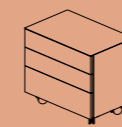

**Storage\_TIN\_CON7045H61**

Width 70  
Depth 45  
Height 61

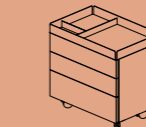

**Storage\_TIN\_COT7045H68**

Width 70  
Depth 45  
Height 68

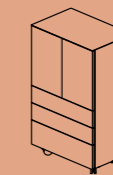

**Storage\_TIN\_CON7045H110**

Width 70  
Depth 45  
Height 110

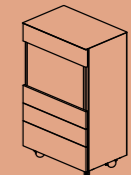

**Storage\_TIN\_COS7045H110**

Width 70  
Depth 45  
Height 110

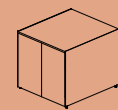

**Storage\_TIN\_CAB8090H75**

Width 80  
Depth 90  
Height 75

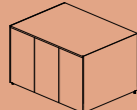

**Storage\_TIN\_CAB12090H75**

Width 120  
Depth 90  
Height 75

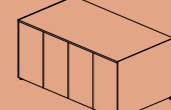

**Storage\_TIN\_CAB16090H75**

Width 160  
Depth 90  
Height 75

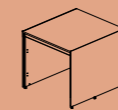

**Storage\_TIN\_CAT8090H75**

Width 80  
Depth 90  
Height 75

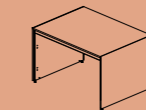

**Storage\_TIN\_CAT12090H75**

Width 120  
Depth 90  
Height 75

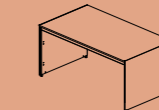

**Storage\_TIN\_CAT16090H75**

Width 160  
Depth 90  
Height 75

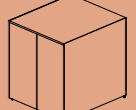

**Storage\_TIN\_CAB8090H90**

Width 80  
Depth 90  
Height 90

# Tin

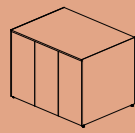

**Storage\_TIN\_CAB12090H90**

Width 120  
Depth 90  
Height 90

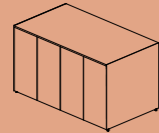

**Storage\_TIN\_CAB16090H90**

Width 160  
Depth 90  
Height 90

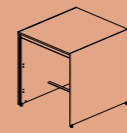

**Storage\_TIN\_CAT8090H90**

Width 80  
Depth 90  
Height 90

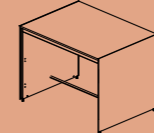

**Storage\_TIN\_CAT12090H90**

Width 120  
Depth 90  
Height 90

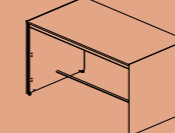

**Storage\_TIN\_CAT16090H90**

Width 160  
Depth 90  
Height 90

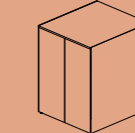

**Storage\_TIN\_CAB8090H105**

Width 80  
Depth 90  
Height 105

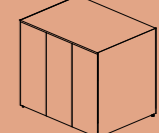

**Storage\_TIN\_CAB12090H105**

Width 120  
Depth 90  
Height 105

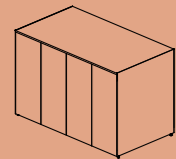

**Storage\_TIN\_CAB16090H105**

Width 160  
Depth 90  
Height 105

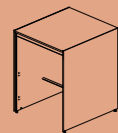

**Storage\_TIN\_CAT8090H105**

Width 80  
Depth 90  
Height 105

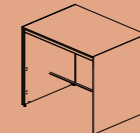

**Storage\_TIN\_CAT12090H105**

Width 120  
Depth 90  
Height 105

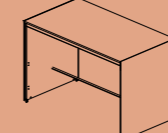

**Storage\_TIN\_CAT16090H105**

Width 160  
Depth 90  
Height 105

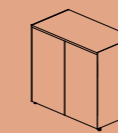

**Storage\_TIN\_CAB8045H75**

Width 80  
Depth 45  
Height 75

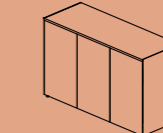

**Storage\_TIN\_CAB12045H75**

Width 120  
Depth 45  
Height 75

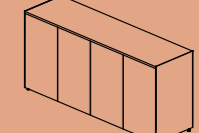

**Storage\_TIN\_CAB16045H75**

Width 160  
Depth 45  
Height 75

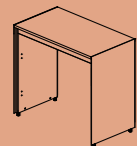

**Storage\_TIN\_CAT8045H75**

Width 80  
Depth 45  
Height 75

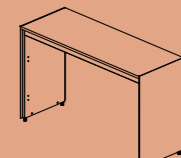

**Storage\_TIN\_CAT12045H75**

Width 120  
Depth 45  
Height 75

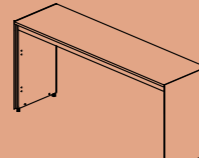

**Storage\_TIN\_CAT16045H75**

Width 160  
Depth 45  
Height 75

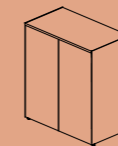

**Storage\_TIN\_CAB8045H90**

Width 80  
Depth 45  
Height 90

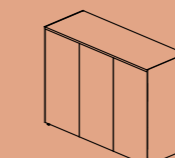

**Storage\_TIN\_CAB12045H90**

Width 120  
Depth 45  
Height 90

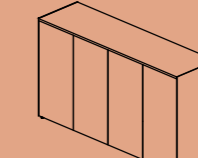

**Storage\_TIN\_CAB16045H90**

Width 160  
Depth 45  
Height 90

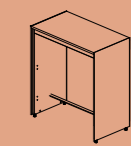

**Storage\_TIN\_CAT8045H90**

Width 80  
Depth 45  
Height 90

# Tin

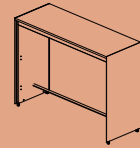

**Storage\_TIN\_CAT12045H105**

Width 120  
Depth 45  
Height 105

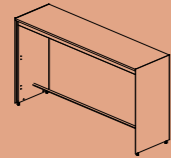

**Storage\_TIN\_CAT16045H105**

Width 160  
Depth 45  
Height 75

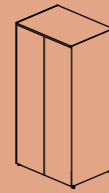

**Storage\_TIN\_VES8060H160**

Width 80  
Depth 60  
Height 160

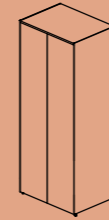

**Storage\_TIN\_VES8060H200**

Width 80  
Depth 60  
Height 200

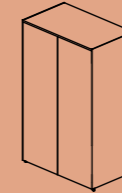

**Storage\_TIN\_VES10060H160**

Width 100  
Depth 60  
Height 160

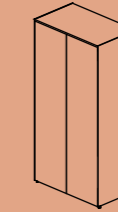

**Storage\_TIN\_VES10060H200**

Width 100  
Depth 60  
Height 200

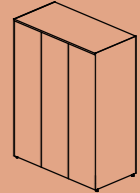

**Storage\_TIN\_VES12060H160**

Width 120  
Depth 60  
Height 160

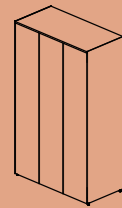

**Storage\_TIN\_VES12060H200**

Width 120  
Depth 60  
Height 200

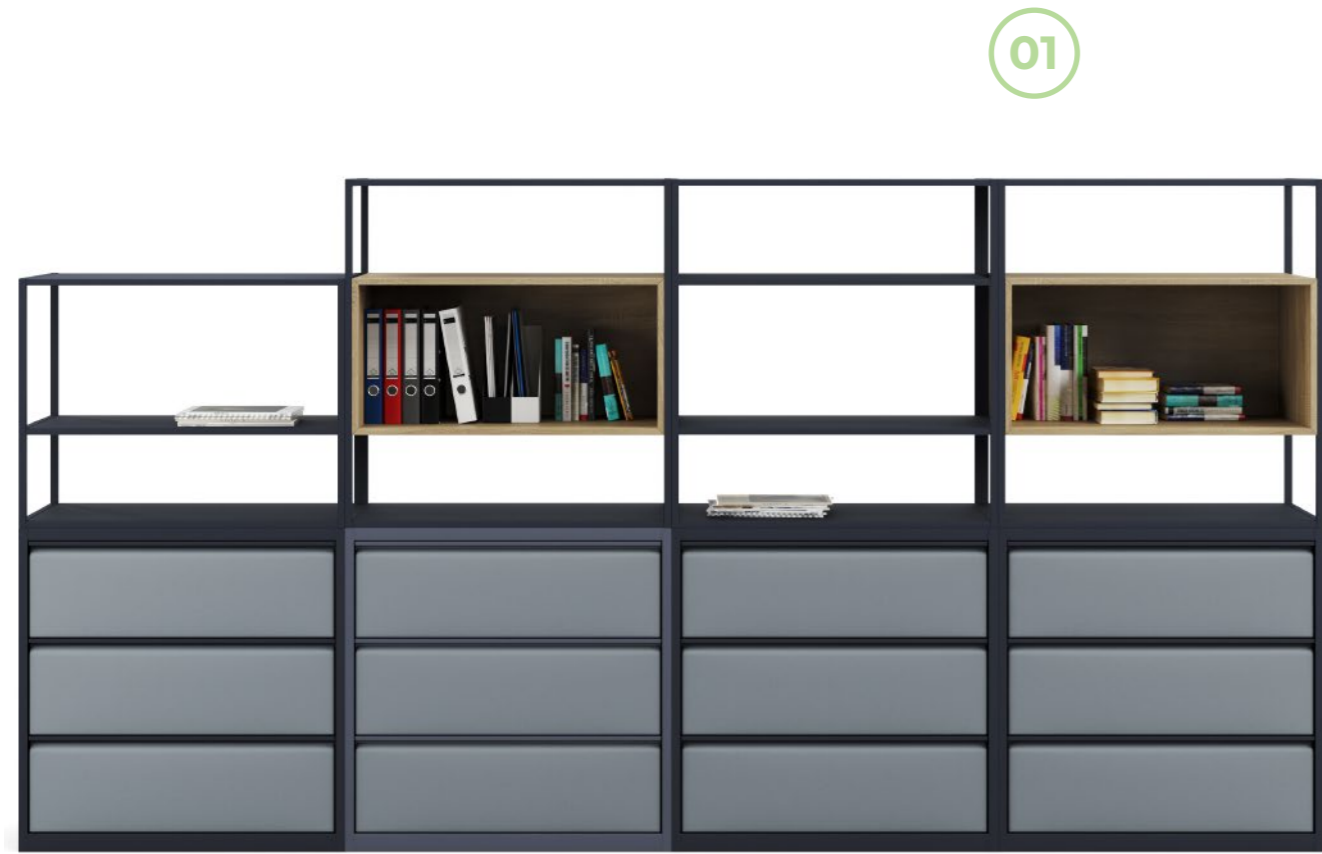

01  
Magneto Shelf



02  
Magneto Locker



03  
Magneto Locker

# Magneto

# Work

## WORKING SPACES

01



01  
Work Console

02



02  
Work Cabinet



#workingspaces2024

# Work

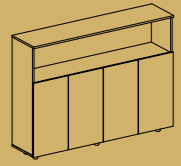

## Work Storage Fullcover

Width 160  
Depth 39  
Height 80

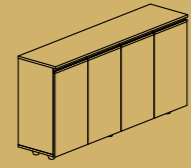

## Work Storage Semicover

Width 160  
Depth 39  
Height 120



#workingspaces2024

# Planet

## WORKING SPACES

01

02



01  
Planet Console



#workingspaces2024

# Planet

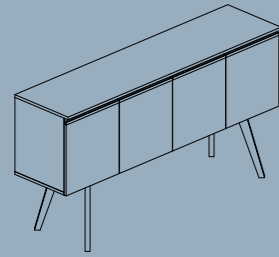

## Planet Storage

Width	180
Depth	45
Height	95



#workspaces2024

# Geo

## WORKING SPACES

01



02



Space Styled,  
Work Perfected.

01  
Geo Console



#workingspaces2024

# Geo

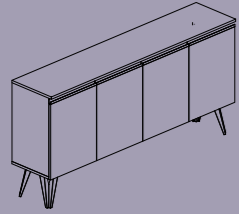

## Geo Storage

Width	180
Depth	39
Height	90

# Breeze

WORKING  
SPACES

01



01  
Breeze Cabinet

Space Styled, Work Perfected.



# Breeze

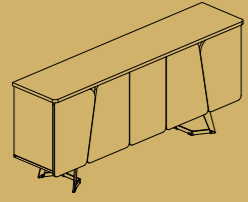

## Executive Storage 200

Width	200
Depth	86
Height	45



#workingspaces2024

# WORKING SPACES

# Eva

01



Space Styled,  
Work Perfected.

01  
Eva Cabinet



#workingspaces2024

# Eva

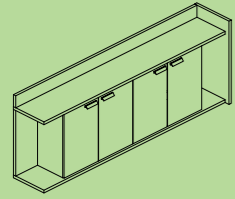

## Console 240

Width 240  
Depth 45  
Height 90

# WORKING SPACES

# Fly

01



Space Styled,  
Work Perfected.

01  
Fly Console



#workingspaces2024

# Fly

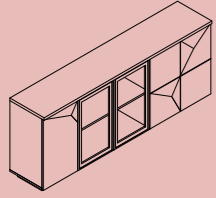

## Console 220

Width 220  
Depth 45  
Height 90

# Loft

## WORKING SPACES

01



01  
Loft Cabinet

### Space Styled, Work Perfected.



#workingspaces2024

# Loft

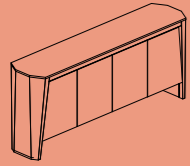

## Console 220

Width 220  
Depth 50  
Height 95

# Majör

## WORKING SPACES



01

Space Styled,  
Work Perfected.

01  
Majör Console



#workingspaces2024

# Majör

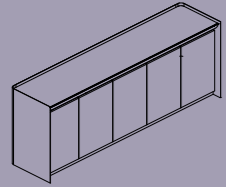

## Console 225

Width 225  
Depth 52  
Height 82



#workingspaces2024

# Motto

## WORKING SPACES

01



Space Styled,  
Work Perfected.

01  
Motto Console



#workingspaces2024

# Motto

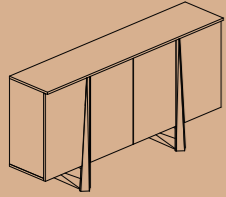

## Console 200

Width 180  
Depth 39  
Height 92

# Valens

WORKING  
SPACES

01



01  
Valens Cabinet

Space Styled, Work Perfected.



#workingspaces2024

# Valens

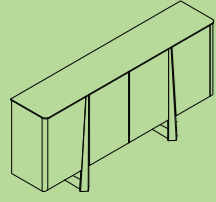

**Console 189**

Width 189  
Depth 39  
Height 91

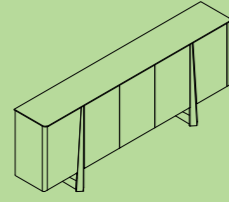

**Console 233**

Width 233  
Depth 39  
Height 91

# Space

## WORKING SPACES

01



01  
Space Console



#workingspaces2024

# Space

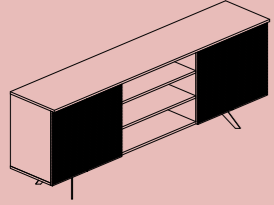

## Console 220

Width 220  
Depth 45  
Height 85

# Viyana

## WORKING SPACES

01



Space Styled,  
Work Perfected.

01  
Viyana Console



#workingspaces2024

# Viyana

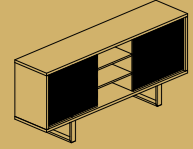

## Console 240

Width 200  
Depth 45  
Height 90

# Zeta

## WORKING SPACES



Space Styled,  
Work Perfected.

01  
Zeta Console



#workingspaces2024

# Zeta

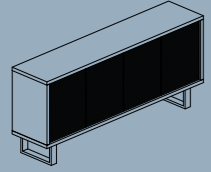

## Console 180

Width	180
Depth	40
Height	80

# Sofa

WORKING  
SPACES

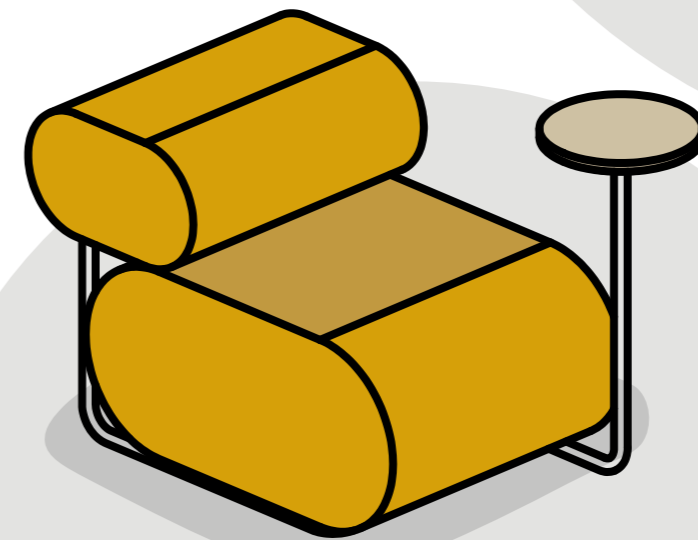
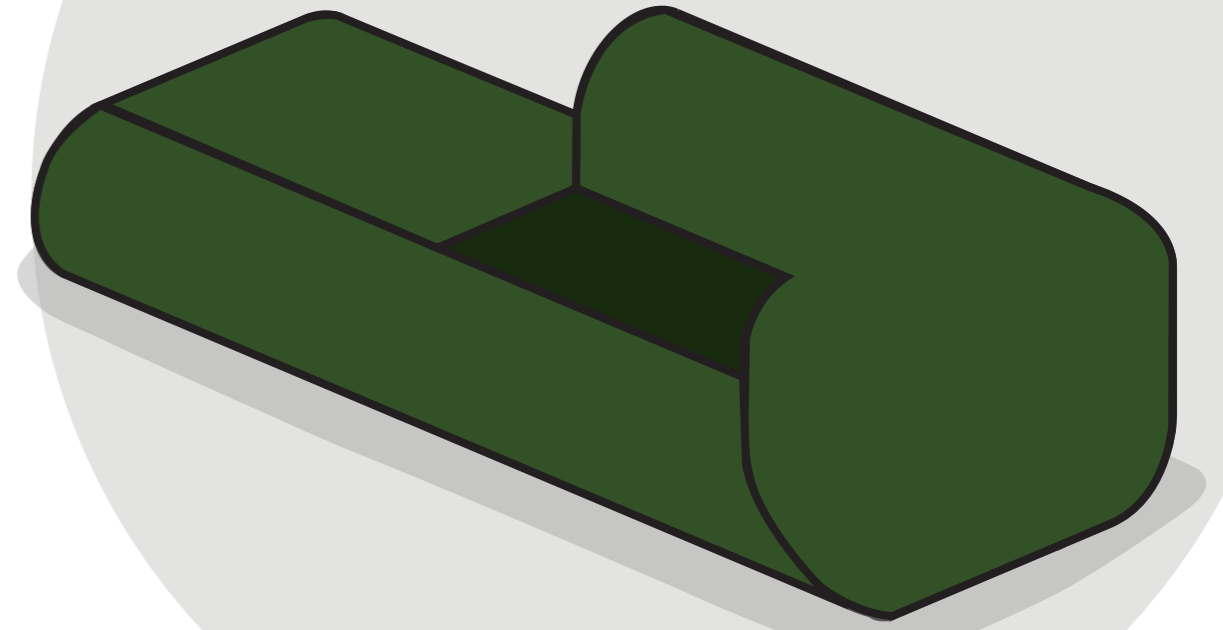

#workingspaces2024

# Cage Lounge

WORKING SPACES



01

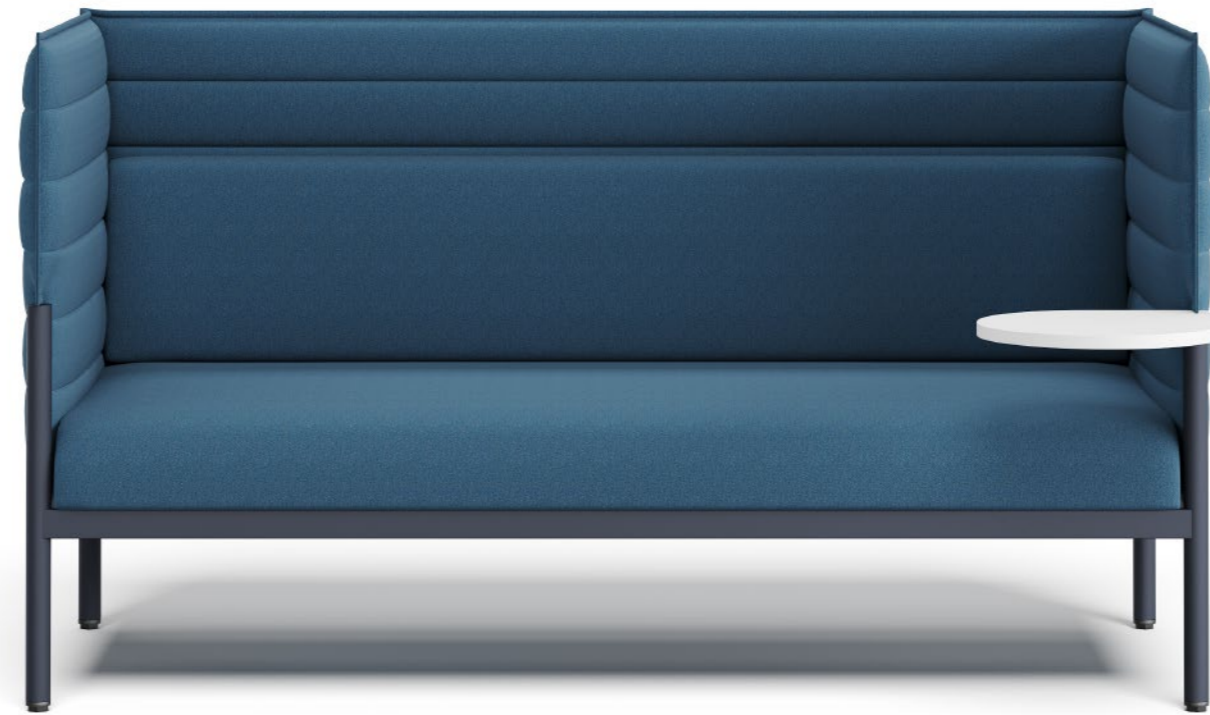

02



03

Space Styled,  
Work Perfected.

01  
Cage Lounge

02  
Cage Sofa

03  
Cage Lounge

  
#workingspaces2024

# Cage Lounge

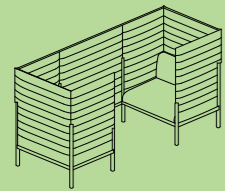

**Seating\_CageLounge\_BTH\_25293**

Width 252  
Depth 93  
Height 127

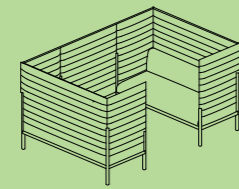

**Seating\_CageLounge\_BTH\_252161**

Width 252  
Depth 161  
Height 127



**Seating\_CageLounge\_HB\_93**

Width 93  
Depth 93  
Height 127

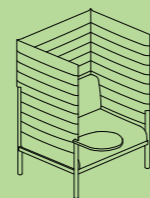

**Seating\_CageLounge\_HB\_93\_STL**

Width 93  
Depth 93  
Height 127



**Seating\_CageLounge\_HB\_93\_STR**

Width 93  
Depth 93  
Height 127

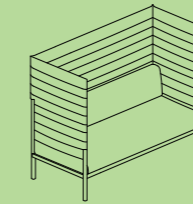

**Seating\_CageLounge\_HB\_161**

Width 161  
Depth 93  
Height 127

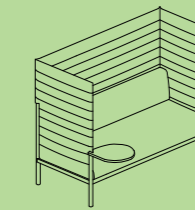

**Seating\_CageLounge\_HB\_161\_STL**

Width 161  
Depth 93  
Height 127

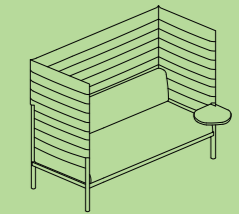

**Seating\_CageLounge\_HB\_161\_STR**

Width 161  
Depth 93  
Height 127



**Seating\_CageLounge\_HB\_M\_93**

Width 93  
Depth 93  
Height 127



**Seating\_CageLounge\_HB\_M\_93\_STL**

Width 93  
Depth 93  
Height 127



**Seating\_CageLounge\_HB\_M\_93\_STR**

Width 93  
Depth 93  
Height 127

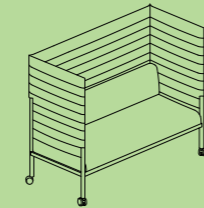

**Seating\_CageLounge\_HB\_M\_161**

Width 161  
Depth 93  
Height 127

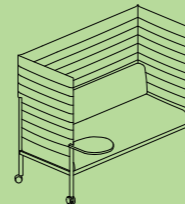

**Seating\_CageLounge\_HB\_M\_161\_STL**

Width 161  
Depth 93  
Height 127

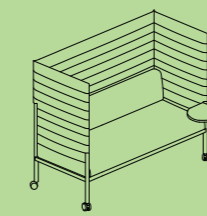

**Seating\_CageLounge\_HB\_M\_161\_STR**

Width 161  
Depth 93  
Height 127

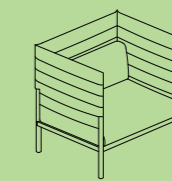

**Seating\_CageLounge\_LB\_93**

Width 93  
Depth 93  
Height 92

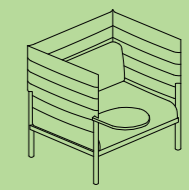

**Seating\_CageLounge\_LB\_93\_STL**

Width 93  
Depth 93  
Height 92

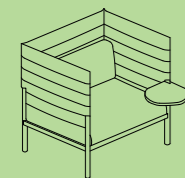

**Seating\_CageLounge\_LB\_93\_STR**

Width 93  
Depth 93  
Height 92

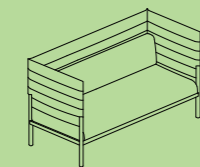

**Seating\_CageLounge\_LB\_161**

Width 161  
Depth 93  
Height 92

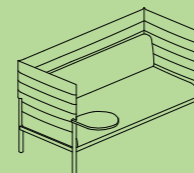

**Seating\_CageLounge\_LB\_161\_STL**

Width 161  
Depth 93  
Height 92

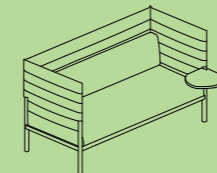

**Seating\_CageLounge\_LB\_161\_STR**

Width 161  
Depth 93  
Height 92

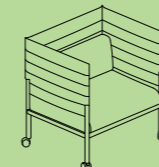

**Seating\_CageLounge\_LB\_M\_93**

Width 93  
Depth 93  
Height 86



**Seating\_CageLounge\_LB\_M\_93\_STL**

Width 93  
Depth 93  
Height 92

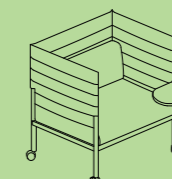

**Seating\_CageLounge\_LB\_M\_93\_STR**

Width 93  
Depth 93  
Height 92

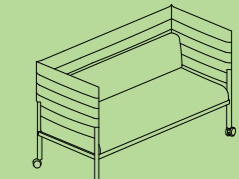

**Seating\_CageLounge\_LB\_M\_161**

Width 161  
Depth 93  
Height 92

# Cage Lounge

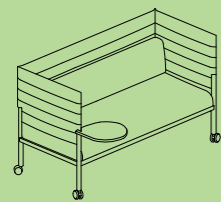

**Seating\_CageLounge\_LB\_M\_161\_STL**

Width 161  
Depth 93  
Height 92

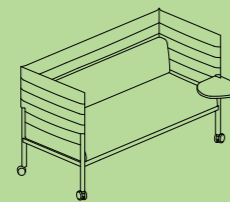

**Seating\_CageLounge\_LB\_M\_161\_STR**

Width 161  
Depth 93  
Height 92

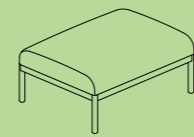

**Seating\_CageLounge\_PUF\_93**

Width 93  
Depth 93  
Height 40

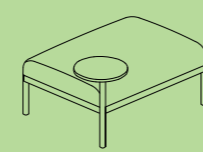

**Seating\_CageLounge\_PUF\_93\_STL**

Width 93  
Depth 93  
Height 40

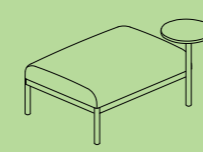

**Seating\_CageLounge\_PUF\_93\_STR**

Width 93  
Depth 93  
Height 40

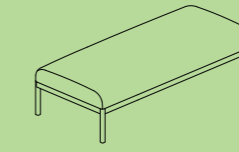

**Seating\_CageLounge\_PUF\_161**

Width 93  
Depth 93  
Height 40

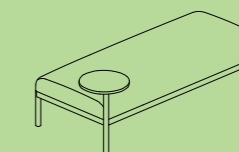

**Seating\_CageLounge\_PUF\_161\_STL**

Width 93  
Depth 93  
Height 40

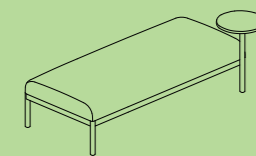

**Seating\_CageLounge\_PUF\_161\_STR**

Width 93  
Depth 93  
Height 40

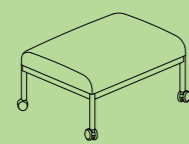

**Seating\_CageLounge\_PUF\_M\_93**

Width 93  
Depth 93  
Height 40

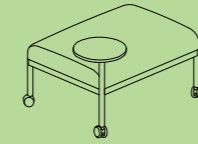

**Seating\_CageLounge\_PUF\_M\_93\_STL**

Width 93  
Depth 93  
Height 40

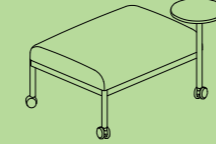

**Seating\_CageLounge\_PUF\_M\_93\_STR**

Width 93  
Depth 93  
Height 40

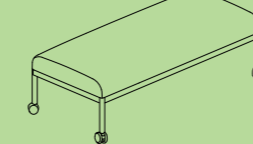

**Seating\_CageLounge\_PUF\_M\_161**

Width 93  
Depth 93  
Height 40

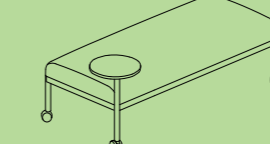

**Seating\_CageLounge\_PUF\_M\_161\_STL**

Width 93  
Depth 93  
Height 40

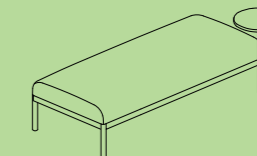

**Seating\_CageLounge\_PUF\_M\_161\_STR**

Width 93  
Depth 93  
Height 40



#workspaces2024



# Puzzle

## WORKING SPACES

01



02



03

01  
**Puzzle Island**

02  
**Puzzle Curve**

03  
**Puzzle Lounge**



#workingspaces2024

Space Styled, Work Perfected.

# Puzzle

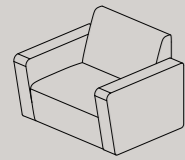

**PUZZLE\_SET 1**

Width 115  
Depth 95  
Height 85  
Seat Height 45

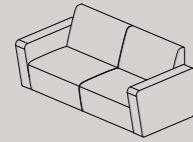

**PUZZLE\_SET 2**

Width 200  
Depth 95  
Height 85  
Seat Height 45

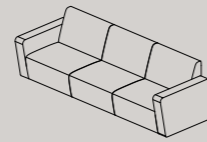

**PUZZLE\_SET 3**

Width 285  
Depth 95  
Height 85  
Seat Height 45

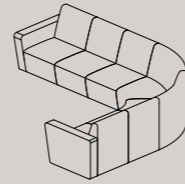

**PUZZLE\_SET 4**

Width 285  
Depth 95  
Height 85  
Seat Height 45

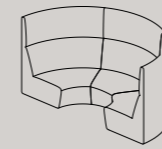

**PUZZLE\_SET 5**

Width 278  
Depth 131  
Height 140  
Angle 60  
Seat Height 45

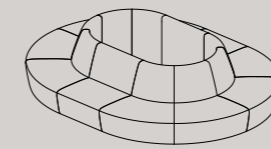

**PUZZLE\_SET 6**

Width 386  
Depth 300  
Height 85  
Angle 45  
Seat Height 45

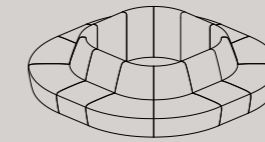

**PUZZLE\_SET 7**

Width 386  
Depth 300  
Height 85  
Angle 45  
Seat Height 45

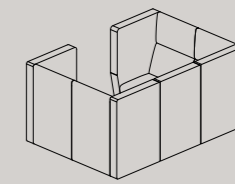

**PUZZLE\_SET 8**

Width 386  
Depth 300  
Height 85  
Angle 45  
Seat Height 45

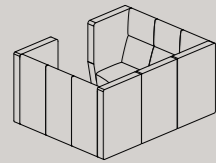

**PUZZLE\_SET 9**

Width 282  
Depth 225  
Height 140  
Seat Height 45

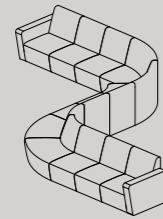

**PUZZLE\_SET 10**

Width 620  
Depth 420  
Height 85  
Seat Height 45

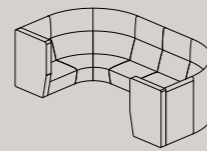

**PUZZLE\_SET 11**

Width 450  
Depth 240  
Height 140  
Angle 45  
Seat Height 45

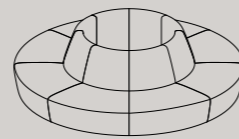

**PUZZLE\_SET 12**

Width 301  
Depth 301  
Height 85  
Angle 45  
Seat Height 45

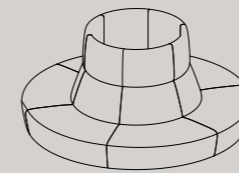

**PUZZLE\_SET 13**

Width 301  
Depth 280  
Height 140  
Angle 45  
Seat Height 45

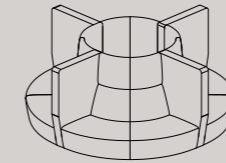

**PUZZLE\_SET 14**

Width 327  
Depth 327  
Height 140  
Angle 45  
Seat Height 45

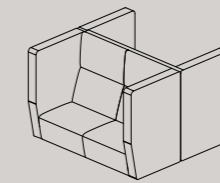

**PUZZLE\_SET 15**

Width 200  
Depth 190  
Height 140  
Seat Height 45

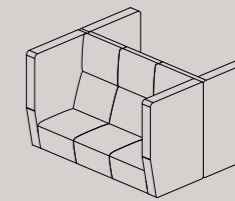

**PUZZLE\_SET 16**

Width 225  
Depth 190  
Height 140  
Seat Height 45

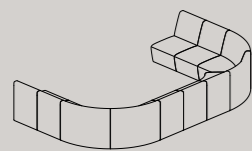

**PUZZLE\_SET 17**

Width 270  
Depth 475  
Height 85  
Seat Height 45

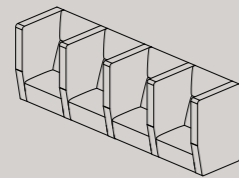

**PUZZLE\_SET 18**

Width 415  
Depth 95  
Height 140  
Seat Height 45

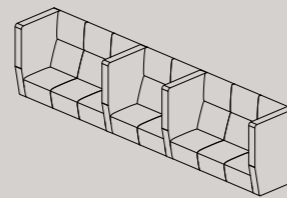

**PUZZLE\_SET 19**

Width 580  
Depth 95  
Height 140  
Seat Height 45

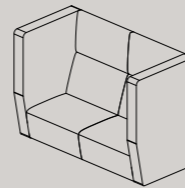

**PUZZLE\_SET 20**

Width 200  
Depth 95  
Height 140  
Seat Height 45

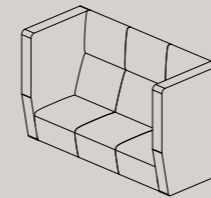

**PUZZLE\_SET 21**

Width 225  
Depth 95  
Height 140  
Seat Height 45

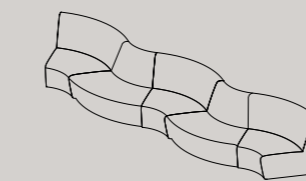

**PUZZLE\_SET 22**

Width 327  
Depth 327  
Height 140  
Angle 45  
Seat Height 45

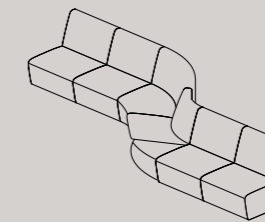

**PUZZLE\_SET 23**

Width 513  
Depth 190  
Height 85  
Seat Height 45

# Puzzle

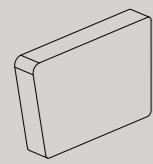

**Seating\_PUZZLE\_ARM**

Width	15
Depth	95
Height	65

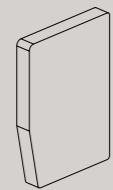

**Seating\_PUZZLE\_ARM\_H140**

Width	15
Depth	95
Height	140

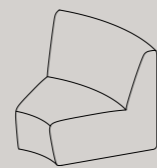

**Seating\_PUZZLE\_CNV45\_107**

Width	107
Depth	84
Height	85
Seat Height	45

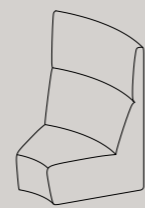

**Seating\_PUZZLE\_CNV45\_107\_H140**

Width	107
Depth	84
Height	140
Angle	45
Seat Height	45

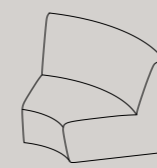

**Seating\_PUZZLE\_CNV60\_140**

Width	140
Depth	88
Height	85
Angle	60
Seat Height	45



**Seating\_PUZZLE\_CNV60\_140\_H140**

Width	140
Depth	78
Height	140
Angle	60
Seat Height	45

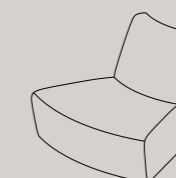

**Seating\_PUZZLE\_CVX45\_115**

Width	115
Depth	84
Height	85
Angle	45
Seat Height	45



**Seating\_PUZZLE\_CVX45\_115\_H140**

Width	115
Depth	84
Height	140
Angle	45
Seat Height	45

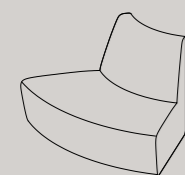

**Seating\_PUZZLE\_CVX60\_150**

Width	150
Depth	88
Height	85
Angle	60
Seat Height	45



**Seating\_PUZZLE\_CVX60\_150\_H140**

Width	150
Depth	88
Height	140
Angle	60
Seat Height	45

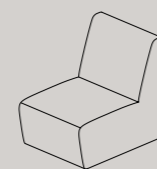

**Seating\_PUZZLE\_LIN65**

Width	65
Depth	95
Height	85
Seat Height	45

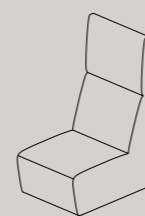

**Seating\_PUZZLE\_LIN65\_H140**

Width	65
Depth	95
Height	140
Seat Height	45

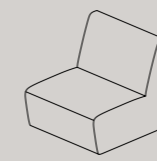

**Seating\_PUZZLE\_LIN85**

Width	85
Depth	95
Height	85
Seat Height	45

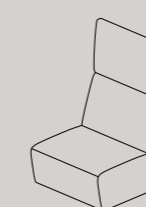

**Seating\_PUZZLE\_LIN85\_H140**

Width	85
Depth	95
Height	140
Seat Height	45

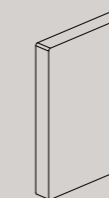

**Seating\_PUZZLE\_WLL90\_H140**

Width	15
Depth	90
Height	140
Seat Height	45

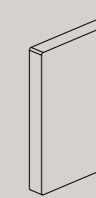

**Seating\_PUZZLE\_WLL96\_H140**

Width	15
Depth	95
Height	140
Angle	45
Seat Height	45

# Odissea

## WORKING SPACES

01



01  
Odissea Chair

02



02  
Odissea Sofa

03



03  
Odissea Chair



#workingspaces2024

# Odissia

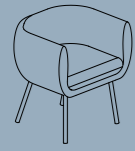

**Seating\_ODISSEA\_Chair\_4leg**

Width	65
Depth	70
Height	77
Seat Height	45



**Seating\_ODISSEA\_Chair\_Rotate**

Width	65
Depth	70
Height	77
Seat Height	45

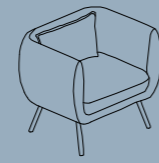

**Seating\_ODISSEA\_Lounge**

Width	84
Depth	70
Height	77
Seat Height	42

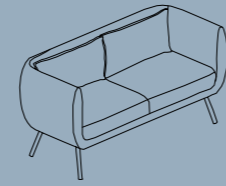

**Seating\_ODISSEA\_Sofa152**

Width	152
Depth	70
Height	77
Seat Height	42

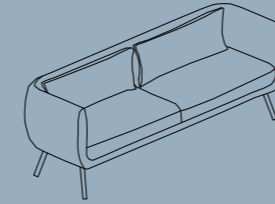

**Seating\_ODISSEA\_Sofa208**

Width	208
Depth	70
Height	77
Seat Height	42

# Space

## WORKING SPACES

01



02



03



01  
Space Armchair

02  
Space Sofa

03  
Space Sofa

  
#workingspaces2024

Space Styled, Work Perfected.

# Space

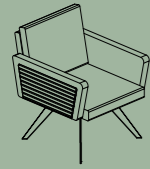

## Seating\_SPACE\_LNG

Width	62
Depth	70
Height	44
Seat Height	85

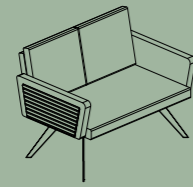

## Seating\_SPACE\_SOF\_110

Width	110
Depth	70
Height	44
Seat Height	85

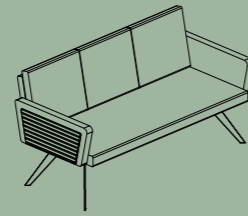

## Seating\_SPACE\_SOF\_160

Width	160
Depth	70
Height	44
Seat Height	85

# Baron



WORKING  
SPACES

01

Space Styled,  
Work Perfected.

01  
Baron Modular Sofa Set

  
#workingspaces2024

# Baron

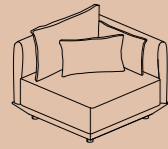

**Seating\_BARON\_CNR9090**

Width 90  
Depth 90  
Height 68  
Seat Height 40

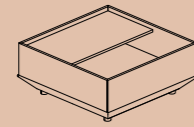

**Seating\_BARON\_CST9090**

Width 90  
Depth 90  
Height 40  
Seat Height 40

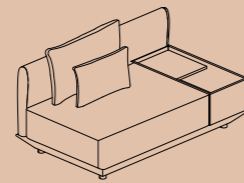

**Seating\_BARON\_LIL15090**

Width 150  
Depth 90  
Height 68  
Seat Height 40

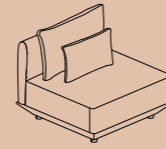

**Seating\_BARON\_LIN9090**

Width 90  
Depth 90  
Height 68  
Seat Height 40

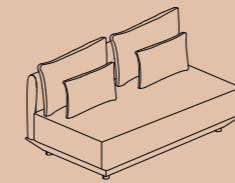

**Seating\_BARON\_LIN15090**

Width 150  
Depth 90  
Height 68  
Seat Height 40

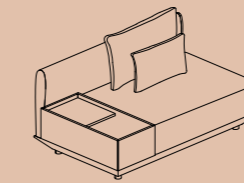

**Seating\_BARON\_LIR15090**

Width 150  
Depth 90  
Height 68  
Seat Height 40

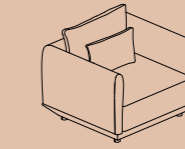

**Seating\_BARON\_LNG10090**

Width 100  
Depth 90  
Height 68  
Seat Height 40

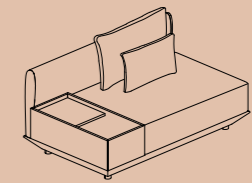

**Seating\_BARON\_MCL16090**

Width 160  
Depth 90  
Height 68  
Seat Height 40

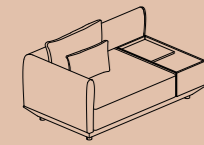

**Seating\_BARON\_MCR16090**

Width 160  
Depth 90  
Height 68  
Seat Height 40

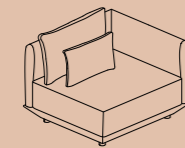

**Seating\_BARON\_MDL10090**

Width 100  
Depth 90  
Height 68  
Seat Height 40

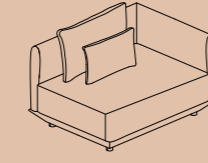

**Seating\_BARON\_MDL12090**

Width 120  
Depth 90  
Height 68  
Seat Height 40

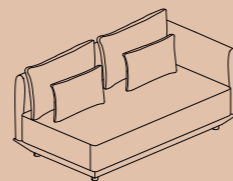

**Seating\_BARON\_MDL16090**

Width 160  
Depth 90  
Height 68  
Seat Height 40

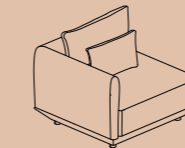

**Seating\_BARON\_MDR10090**

Width 100  
Depth 90  
Height 68  
Seat Height 40

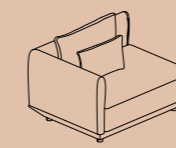

**Seating\_BARON\_MDR12090**

Width 120  
Depth 90  
Height 68  
Seat Height 40

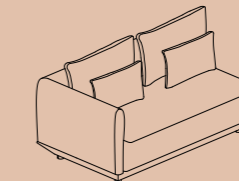

**Seating\_BARON\_MDR16090**

Width 160  
Depth 90  
Height 68  
Seat Height 40

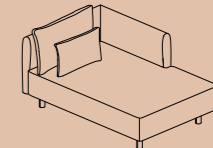

**Seating\_BARON\_MLL100150**

Width 100  
Depth 150  
Height 68  
Seat Height 40

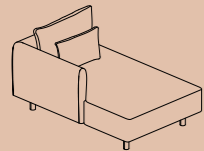

**Seating\_BARON\_MLR100150**

Width 100  
Depth 150  
Height 68  
Seat Height 40

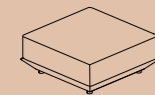

**Seating\_BARON\_PUF9090**

Width 90  
Depth 90  
Height 40  
Seat Height 40

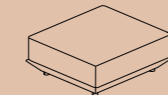

**Seating\_BARON\_PUF10090**

Width 100  
Depth 90  
Height 40  
Seat Height 40

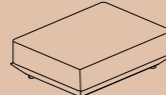

**Seating\_BARON\_PUF12090**

Width 120  
Depth 90  
Height 40  
Seat Height 40



**Seating\_BARON\_PUF15090**

Width 150  
Depth 90  
Height 40  
Seat Height 40

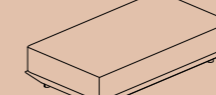

**Seating\_BARON\_PUF16090**

Width 160  
Depth 90  
Height 40  
Seat Height 40

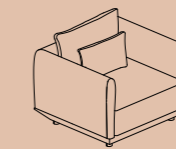

**Seating\_BARON\_LNG10090**

Width 100  
Depth 90  
Height 68  
Seat Height 40

# Solar

## WORKING SPACES

01



02

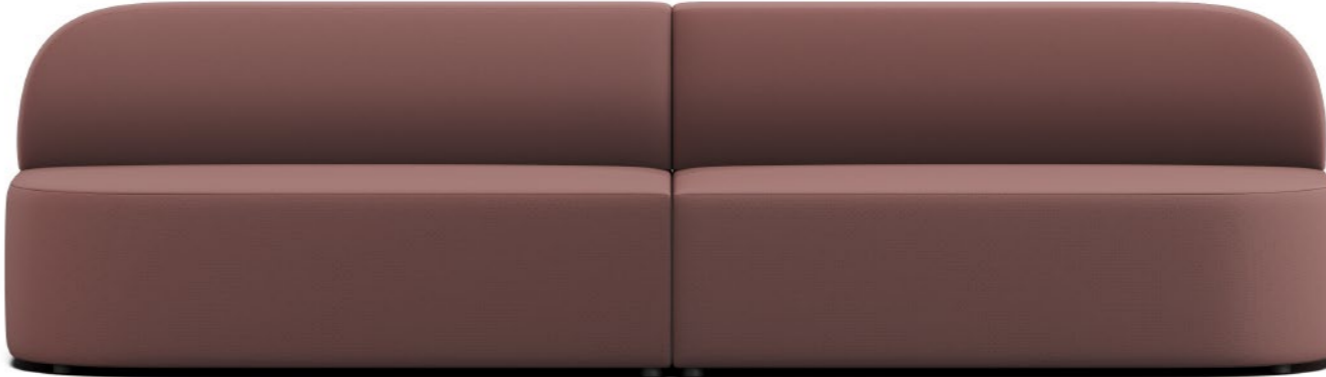

03



01  
Solar Modular Sofa Set



#workingspaces2024

### Space Styled, Work Perfected.

# Solar

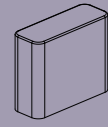

**Seating\_SOLAR\_ARM2568H55**

Width 25  
Depth 68  
Height 55

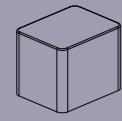

**Seating\_SOLAR\_ARM5468H55**

Width 54  
Depth 68  
Height 55

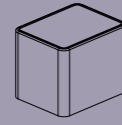

**Seating\_SOLAR\_ARF5468H55**

Width 54  
Depth 68  
Height 55

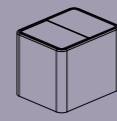

**Seating\_SOLAR\_ARH5468H55**

Width 54  
Depth 68  
Height 55

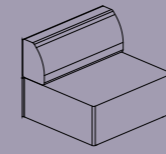

**Seating\_SOLAR\_LIN100**

Width 100  
Depth 90  
Height 80  
Seat Height 43

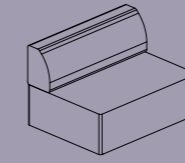

**Seating\_SOLAR\_LIN120**

Width 120  
Depth 90  
Height 80  
Seat Height 43

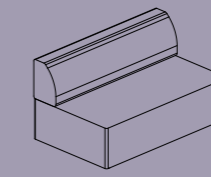

**Seating\_SOLAR\_LIN150**

Width 150  
Depth 90  
Height 80  
Seat Height 43

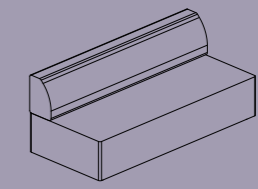

**Seating\_SOLAR\_LIN200**

Width 200  
Depth 90  
Height 80  
Seat Height 43

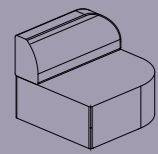

**Seating\_SOLAR\_HCR100**

Width 100  
Depth 90  
Height 80  
Seat Height 43

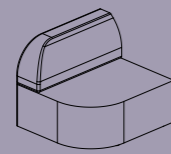

**Seating\_SOLAR\_HCL100**

Width 100  
Depth 90  
Height 80  
Seat Height 43

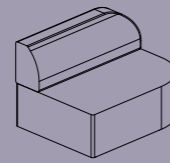

**Seating\_SOLAR\_HCR120**

Width 120  
Depth 90  
Height 80  
Seat Height 43

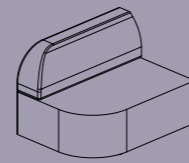

**Seating\_SOLAR\_HCL120**

Width 120  
Depth 90  
Height 80  
Seat Height 43

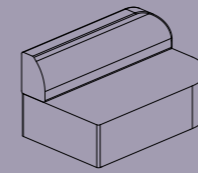

**Seating\_SOLAR\_HCR150**

Width 150  
Depth 90  
Height 80  
Seat Height 43

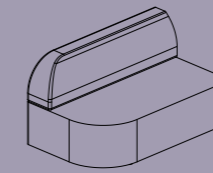

**Seating\_SOLAR\_HCL150**

Width 150  
Depth 90  
Height 80  
Seat Height 43

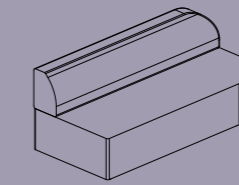

**Seating\_SOLAR\_HCR200**

Width 200  
Depth 90  
Height 80  
Seat Height 43

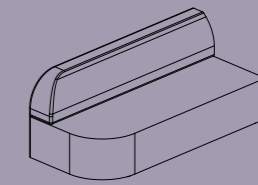

**Seating\_SOLAR\_HCL200**

Width 200  
Depth 90  
Height 80  
Seat Height 43

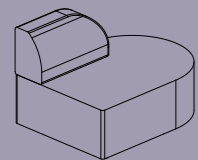

**Seating\_SOLAR\_FCR120**

Width 120  
Depth 90  
Height 80  
Seat Height 43

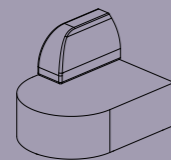

**Seating\_SOLAR\_FCL120**

Width 120  
Depth 90  
Height 80  
Seat Height 43

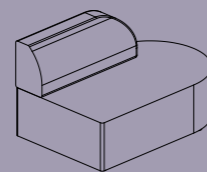

**Seating\_SOLAR\_FCR140**

Width 140  
Depth 90  
Height 80  
Seat Height 43

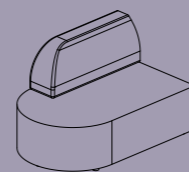

**Seating\_SOLAR\_FCL140**

Width 140  
Depth 90  
Height 80  
Seat Height 43

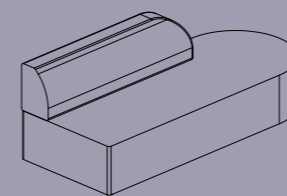

**Seating\_SOLAR\_FCR220**

Width 220  
Depth 90  
Height 80  
Seat Height 43

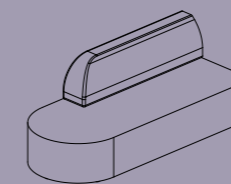

**Seating\_SOLAR\_FCL220**

Width 220  
Depth 90  
Height 80  
Seat Height 43

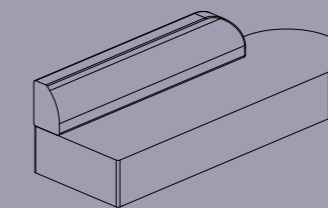

**Seating\_SOLAR\_FCR270**

Width 270  
Depth 90  
Height 80  
Seat Height 43

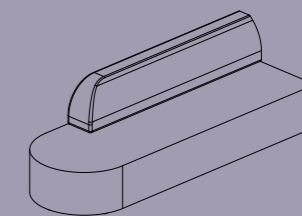

**Seating\_SOLAR\_FCL270**

Width 270  
Depth 90  
Height 80  
Seat Height 43

# Solar

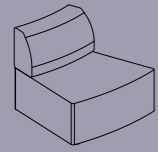

**Seating\_SOLAR\_CN100**

Width	100
Depth	90
Height	80
Seat Height	43

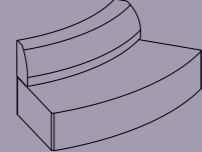

**Seating\_SOLAR\_CN200**

Width	200
Depth	90
Height	80
Seat Height	43

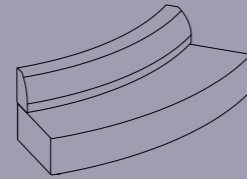

**Seating\_SOLAR\_CN275**

Width	275
Depth	90
Height	80
Seat Height	43

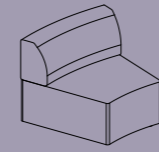

**Seating\_SOLAR\_CN100**

Width	100
Depth	90
Height	80
Seat Height	43

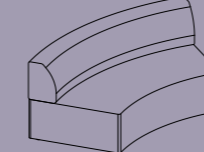

**Seating\_SOLAR\_CN200**

Width	200
Depth	90
Height	80
Seat Height	43

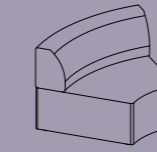

**Seating\_SOLAR\_CN125**

Width	125
Depth	90
Height	80
Seat Height	43

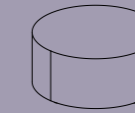

**Seating\_SOLAR\_PUF90**

Width	90
Depth	90
Height	43
Seat Height	43

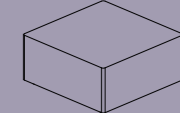

**Seating\_SOLAR\_PUF9090**

Width	90
Depth	90
Height	43
Seat Height	43

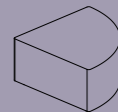

**Seating\_SOLAR\_PUF90R**

Width	90
Depth	90
Height	43
Seat Height	43

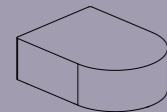

**Seating\_SOLAR\_PUF120**

Width	120
Depth	90
Height	43
Seat Height	43

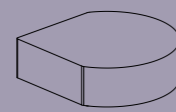

**Seating\_SOLAR\_PUF126**

Width	126
Depth	90
Height	43
Seat Height	43

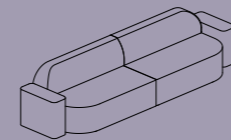

**SOLAR\_SET 1**

Width	350
Depth	90
Height	80
Seat Height	43

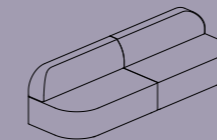

**SOLAR\_SET 2**

Width	300
Depth	90
Height	80
Seat Height	43

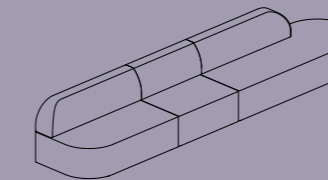

**SOLAR\_SET 3**

Width	520
Depth	90
Height	80
Seat Height	43

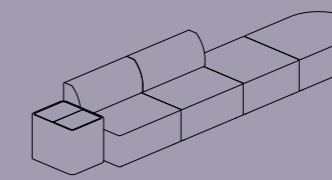

**SOLAR\_SET 4**

Width	465
Depth	90
Height	80
Seat Height	43

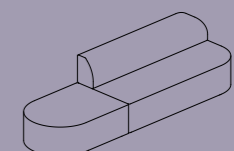

**SOLAR\_SET 5**

Width	320
Depth	90
Height	80
Seat Height	43

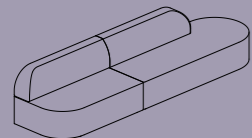

**SOLAR\_SET 6**

Width	370
Depth	90
Height	80
Seat Height	43

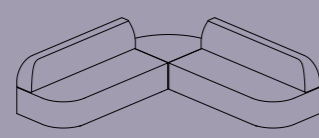

**SOLAR\_SET 7**

Width	290
Depth	290
Height	80
Seat Height	43

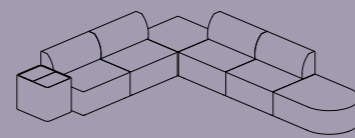

**SOLAR\_SET 8**

Width	345
Depth	410
Height	80
Seat Height	43

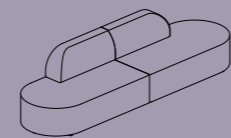

**SOLAR\_SET 9**

Width	340
Depth	90
Height	80
Seat Height	43

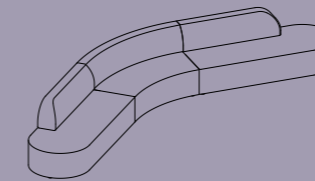

**SOLAR\_SET 10**

Width	576
Depth	176
Height	80
Seat Height	43

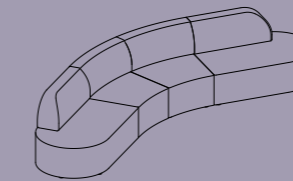

**SOLAR\_SET 11**

Width	426
Depth	143
Height	80
Seat Height	43

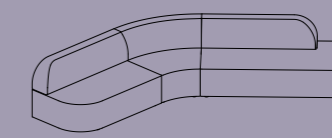

**SOLAR\_SET 12**

Width	400
Depth	255
Height	80
Seat Height	43

# Morn

01



02



03



01  
Morn Armchair

02  
Morn Sofa

03  
Morn Sofa

Space Styled, Work Perfected.



#workspaces2024

# Morn

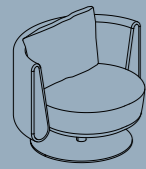

**Seating\_MORN\_LNG**

Width	80
Depth	70
Height	65
Seat Height	36

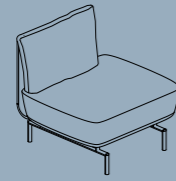

**Seating\_MORN\_LNL**

Width	74
Depth	75
Height	68
Seat Height	36

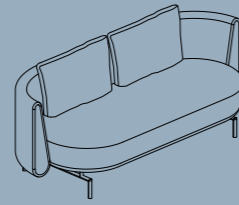

**Seating\_MORN\_SOF\_180**

Width	180
Depth	75
Height	65
Seat Height	36

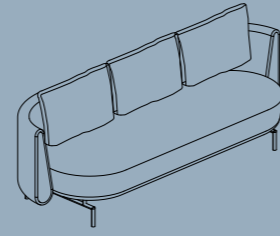

**Seating\_MORN\_SOF\_210**

Width	210
Depth	75
Height	65
Seat Height	36

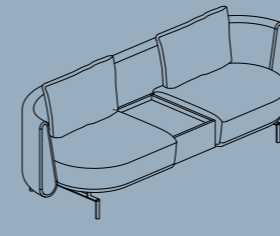

**Seating\_MORN\_SOM\_210**

Width	210
Depth	75
Height	68
Seat Height	36

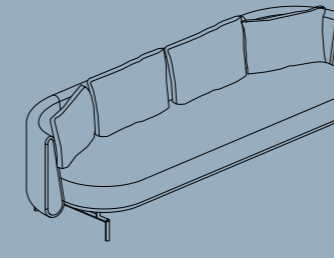

**Seating\_MORN\_SOF\_240**

Width	240
Depth	75
Height	65
Seat Height	36

# Medy

WORKING  
SPACES

01

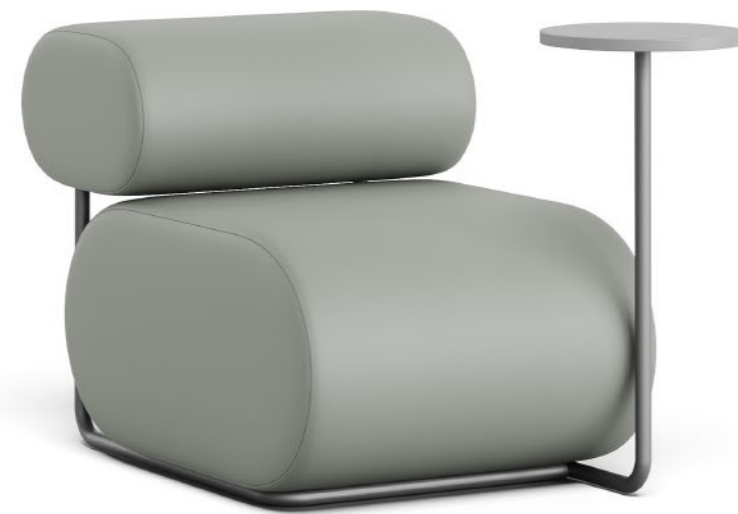

02

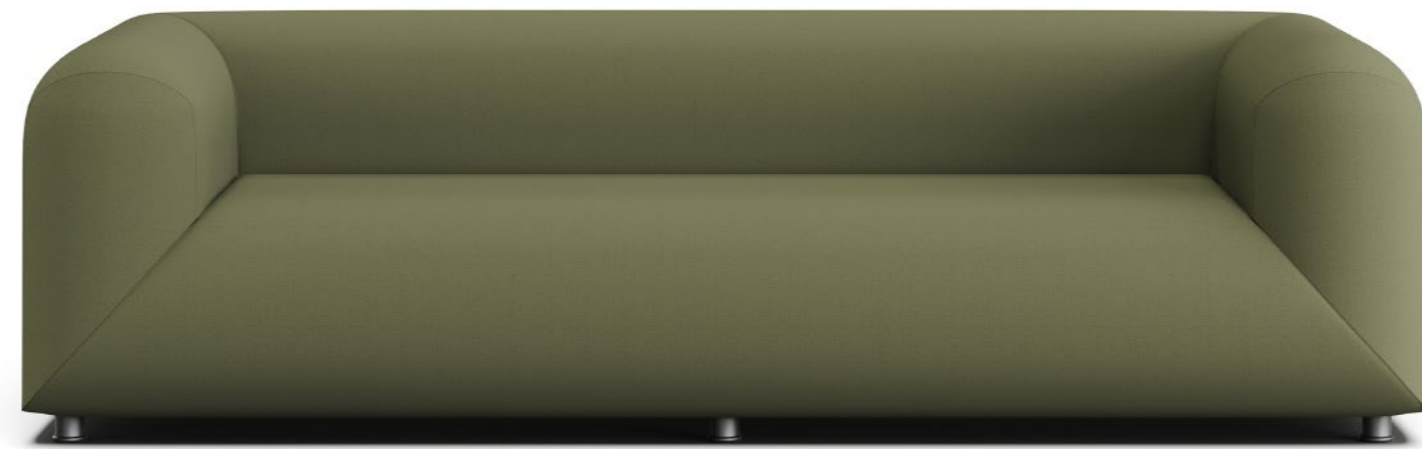

03



01  
Medy Armchair

02  
Medy Sofa

03  
Medy Sofa



#workingspaces2024

# Medy

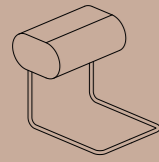

**Seating\_MEDY\_LBS60**

Width 60  
Depth 78  
Height 65

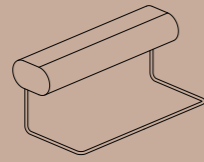

**Seating\_MEDY\_LBS150**

Width 150  
Depth 78  
Height 65

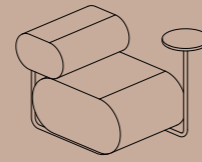

**Seating\_MEDY\_LCL6095**

Width 60  
Depth 95  
Height 65  
Seat Height 40

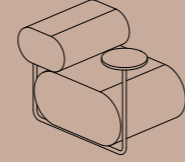

**Seating\_MEDY\_LCR6095**

Width 60  
Depth 95  
Height 65  
Seat Height 40

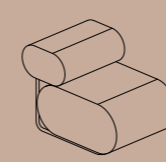

**Seating\_MEDY\_LNG6095**

Width 60  
Depth 95  
Height 65  
Seat Height 40

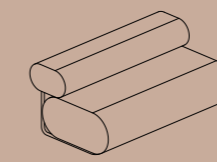

**Seating\_MEDY\_LNG15095**

Width 150  
Depth 95  
Height 65  
Seat Height 40

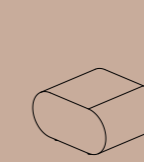

**Seating\_MEDY\_LPF6080**

Width 60  
Depth 80  
Height 40  
Seat Height 40

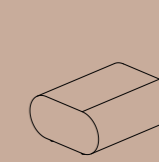

**Seating\_MEDY\_LPF9080**

Width 90  
Depth 80  
Height 40  
Seat Height 40

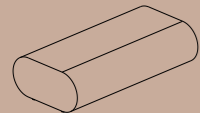

**Seating\_MEDY\_LPF15080**

Width 150  
Depth 80  
Height 40  
Seat Height 40

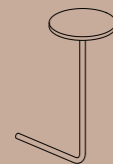

**Seating\_MEDY\_MCT30**

Height 68  
Dim 30

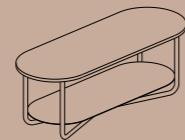

**Seating\_MEDY\_MCT12045**

Width 120  
Depth 45  
Height 42

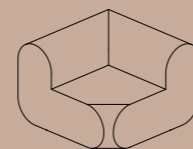

**Seating\_MEDY\_MDC9595**

Width 95  
Depth 95  
Height 70  
Seat Height 40

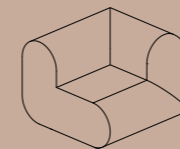

**Seating\_MEDY\_MDL9090**

Width 90  
Depth 90  
Height 70  
Seat Height 40

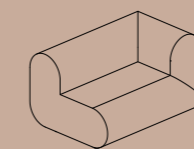

**Seating\_MEDY\_MDL12590**

Width 125  
Depth 90  
Height 70  
Seat Height 40

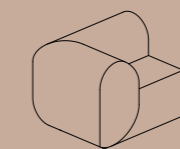

**Seating\_MEDY\_MDR9090**

Width 90  
Depth 90  
Height 70  
Seat Height 40

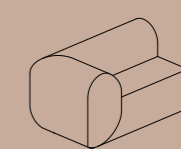

**Seating\_MEDY\_MDR12590**

Width 125  
Depth 90  
Height 70  
Seat Height 40

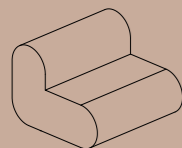

**Seating\_MEDY\_MDS9090**

Width 90  
Depth 90  
Height 70  
Seat Height 40

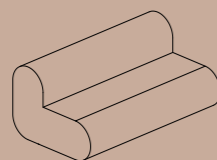

**Seating\_MEDY\_MDS15090**

Width 150  
Depth 90  
Height 70  
Seat Height 40

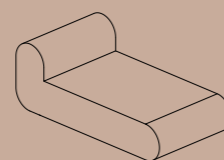

**Seating\_MEDY\_MDS90180**

Width 90  
Depth 180  
Height 70  
Seat Height 40

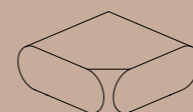

**Seating\_MEDY\_PFC9595**

Width 95  
Depth 95  
Height 40  
Seat Height 40

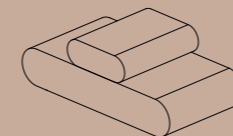

**Seating\_MEDY\_PFD90180**

Width 90  
Depth 180  
Height 65  
Seat Height 40

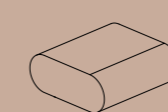

**Seating\_MEDY\_PFL9090**

Width 90  
Depth 90  
Height 40  
Seat Height 40

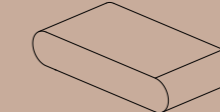

**Seating\_MEDY\_PFL90180**

Width 180  
Depth 90  
Height 40  
Seat Height 40

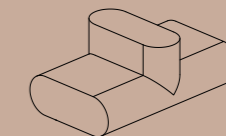

**Seating\_MEDY\_PFT15090**

Width 150  
Depth 90  
Height 67  
Seat Height 40



#workingspaces2024

# Medy

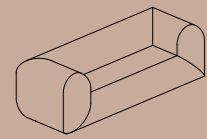

**Seating\_MEDY\_SOF210**

Width 210  
Depth 90  
Height 70  
Seat Height 40

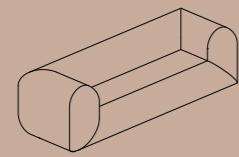

**Seating\_MEDY\_SOF230**

Width 230  
Depth 90  
Height 70  
Seat Height 40

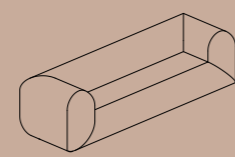

**Seating\_MEDY\_SOF250**

Width 250  
Depth 90  
Height 70  
Seat Height 40

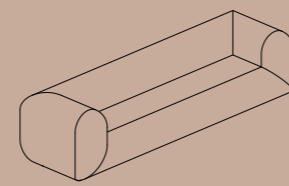

**Seating\_MEDY\_SOF280**

Width 280  
Depth 90  
Height 70  
Seat Height 40

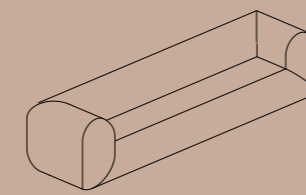

**Seating\_MEDY\_SOF300**

Width 300  
Depth 90  
Height 70  
Seat Height 40

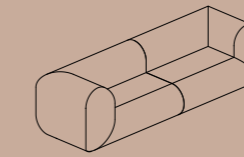

**MEDY\_SET 3**

Width 250  
Depth 90  
Height 70  
Seat Height 40

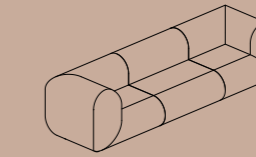

**MEDY\_SET 4**

Width 270  
Depth 90  
Height 70  
Seat Height 40

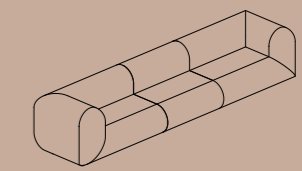

**MEDY\_SET 5**

Width 340  
Depth 90  
Height 70  
Seat Height 40

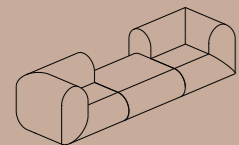

**MEDY\_SET 6**

Width 270  
Depth 90  
Height 70  
Seat Height 40

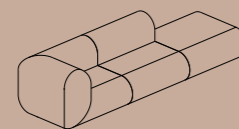

**MEDY\_SET 7**

Width 270  
Depth 90  
Height 70  
Seat Height 40

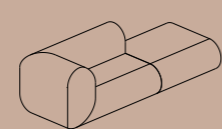

**MEDY\_SET 8**

Width 215  
Depth 90  
Height 70  
Seat Height 40

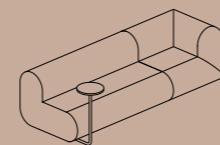

**MEDY\_SET 9**

Width 240  
Depth 90  
Height 70  
Seat Height 40

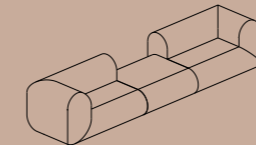

**MEDY\_SET 10**

Width 340  
Depth 90  
Height 70  
Seat Height 40

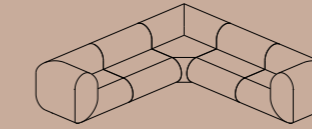

**MEDY\_SET 13**

Width 275  
Depth 275  
Height 70  
Seat Height 40

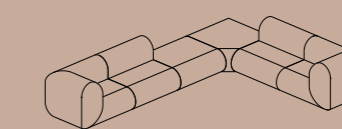

**MEDY\_SET 14**

Width 365  
Depth 275  
Height 70  
Seat Height 40

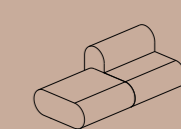

**MEDY\_SET 20**

Width 180  
Depth 90  
Height 70  
Seat Height 40

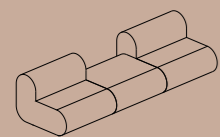

**MEDY\_SET 21**

Width 270  
Depth 90  
Height 70  
Seat Height 40

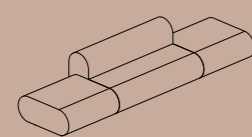

**MEDY\_SET 22**

Width 270  
Depth 90  
Height 70  
Seat Height 40

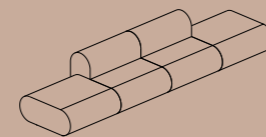

**MEDY\_SET 23**

Width 360  
Depth 90  
Height 70  
Seat Height 40

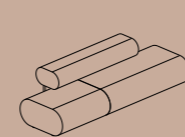

**MEDY\_SET 39**

Width 240  
Depth 95  
Height 65  
Seat Height 40

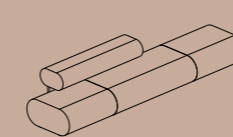

**MEDY\_SET 40**

Width 330  
Depth 95  
Height 65  
Seat Height 40

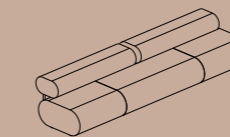

**MEDY\_SET 41**

Width 330  
Depth 95  
Height 65  
Seat Height 40

# Joker

WORKING  
SPACES

01



01  
Joker Sofa Family



#workingspaces2024

# Joker

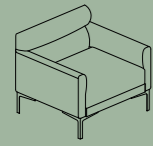

**Seating\_JOKER\_LNG**

Width	73
Depth	80
Height	68
Seat Height	40

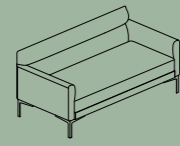

**Seating\_JOKER\_SOF\_150**

Width	150
Depth	73
Height	68
Seat Height	40

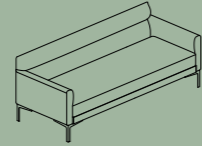

**Seating\_JOKER\_SOF\_180**

Width	180
Depth	73
Height	68
Seat Height	40

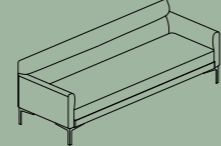

**Seating\_JOKER\_SOF\_210**

Width	210
Depth	73
Height	68
Seat Height	40

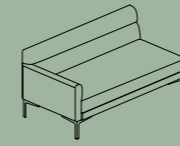

**Seating\_JOKER\_SFR\_143**

Width	143
Depth	73
Height	68
Seat Height	40

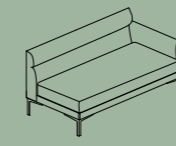

**Seating\_JOKER\_SFL\_143**

Width	143
Depth	73
Height	68
Seat Height	40

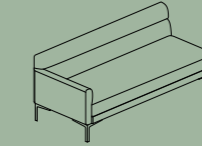

**Seating\_JOKER\_SFR\_173**

Width	173
Depth	73
Height	68
Seat Height	40

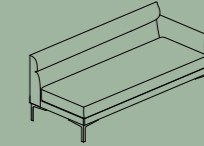

**Seating\_JOKER\_SFL\_173**

Width	173
Depth	73
Height	68
Seat Height	40

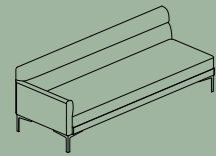

**Seating\_JOKER\_SFR\_203**

Width	203
Depth	73
Height	68
Seat Height	40

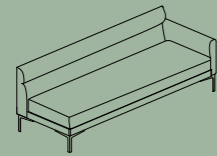

**Seating\_JOKER\_SFL\_203**

Width	203
Depth	73
Height	68
Seat Height	40

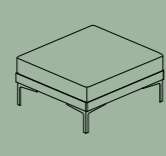

**Seating\_JOKER\_PUF80**

Width	80
Depth	73
Height	40
Seat Height	25

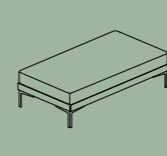

**Seating\_JOKER\_PUF136**

Width	136
Depth	73
Height	40
Seat Height	25

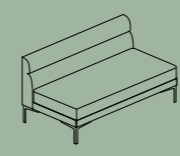

**Seating\_JOKER\_LIN\_136**

Width	136
Depth	73
Height	68
Seat Height	40

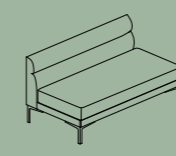

**Seating\_JOKER\_LIL\_136**

Width	136
Depth	73
Height	68
Seat Height	40

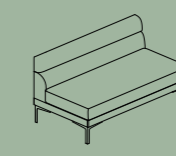

**Seating\_JOKER\_LIR\_136**

Width	136
Depth	73
Height	68
Seat Height	40

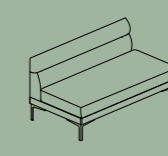

**Seating\_JOKER\_LND\_136**

Width	136
Depth	73
Height	68
Seat Height	40

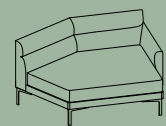

**Seating\_JOKER\_CRL\_140**

Width	140
Depth	100
Height	68
Seat Height	40



**Seating\_JOKER\_CRR\_140**

Width	140
Depth	100
Height	68
Seat Height	40



**Seating\_JOKER\_COL\_132**

Width	132
Depth	100
Height	68
Seat Height	40



**Seating\_JOKER\_COR\_132**

Width	132
Depth	100
Height	68
Seat Height	40

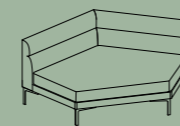

**Seating\_JOKER\_CRM\_168**

Width	168
Depth	100
Height	68
Seat Height	40

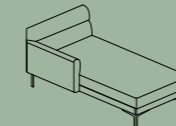

**Seating\_JOKER\_CLR\_84155**

Width	155
Depth	84
Height	68
Seat Height	40

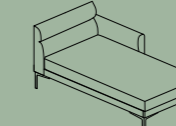

**Seating\_JOKER\_CLL\_84155**

Width	155
Depth	84
Height	68
Seat Height	40

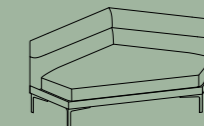

**Seating\_JOKER\_CND\_168**

Width	168
Depth	153
Height	68
Seat Height	40

# Joker

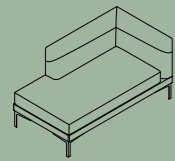

**Seating\_JOKER\_JSL\_135**

Width 135  
Depth 73  
Height 68  
Seat Height 40

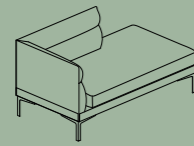

**Seating\_JOKER\_JSR\_135**

Width 135  
Depth 73  
Height 68  
Seat Height 40

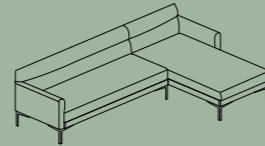

**JOKER\_SET 1**

Width 257  
Depth 155  
Height 68  
Seat Height 40

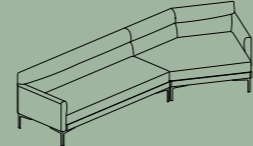

**JOKER\_SET 2**

Width 312  
Depth 120  
Height 68  
Seat Height 40

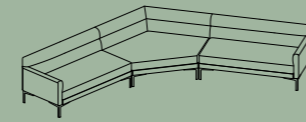

**JOKER\_SET 3**

Width 360  
Depth 245  
Height 68  
Seat Height 40

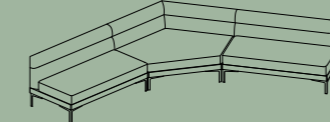

**JOKER\_SET 4**

Width 350  
Depth 240  
Height 68  
Seat Height 40

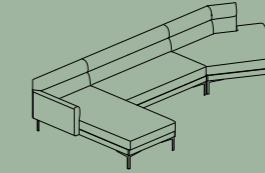

**JOKER\_SET 5**

Width 353  
Depth 155  
Height 68  
Seat Height 40

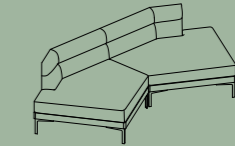

**JOKER\_SET 6**

Width 264  
Depth 120  
Height 68  
Seat Height 40

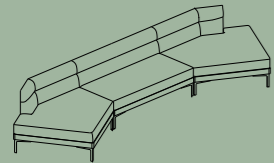

**JOKER\_SET 7**

Width 400  
Depth 120  
Height 68  
Seat Height 40

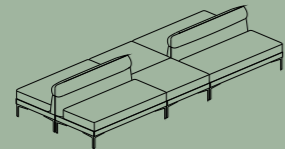

**JOKER\_SET 8**

Width 352  
Depth 146  
Height 68  
Seat Height 40

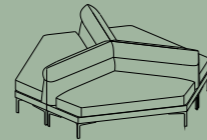

**JOKER\_SET 9**

Width 187  
Depth 216  
Height 68  
Seat Height 40

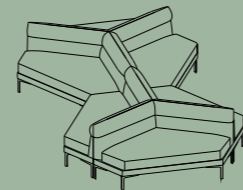

**JOKER\_SET 10**

Width 375  
Depth 216  
Height 68  
Seat Height 40

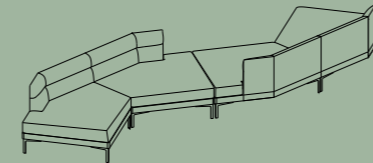

**JOKER\_SET 11**

Width 480  
Depth 155  
Height 68  
Seat Height 40



#workspaces2024

# Show

## WORKING SPACES

01

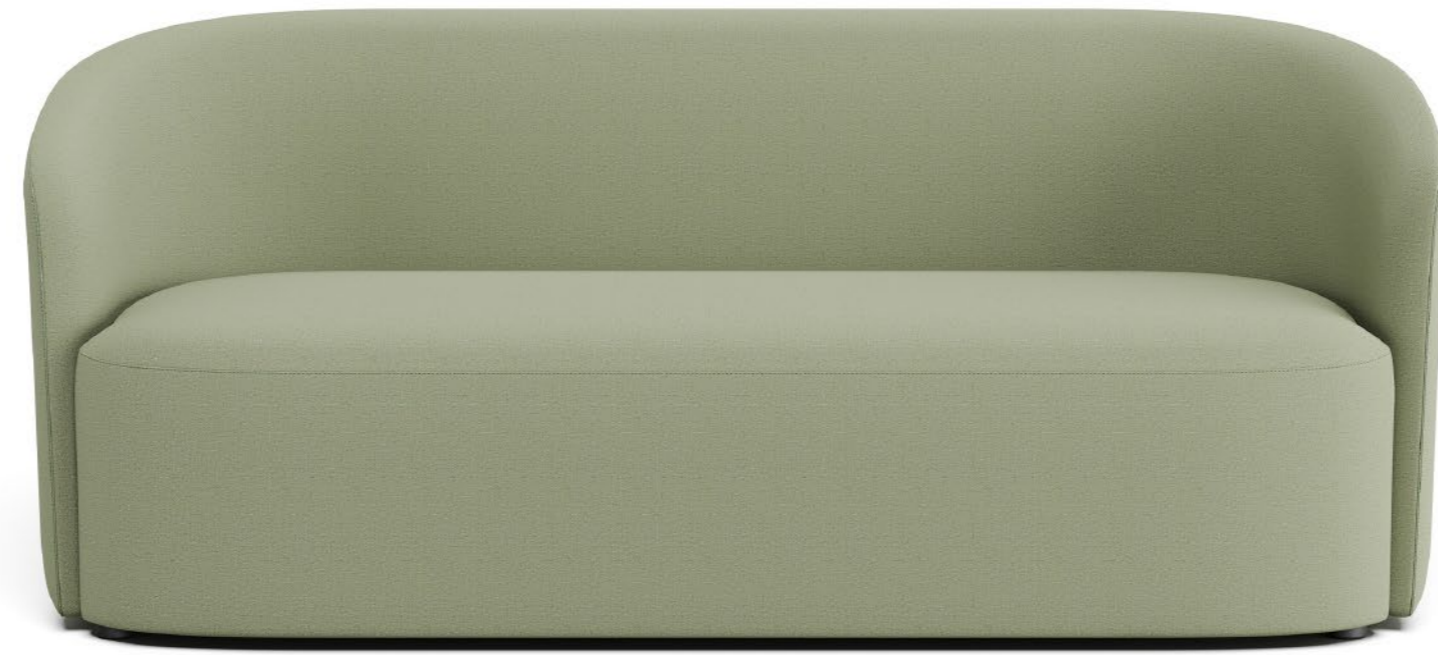

02

03



01  
Show Armchair

02  
Show Sofa

03  
Show Armchair



#workingspaces2024

# Show

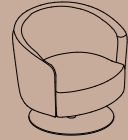

## Show 1

Width	87
Depth	73
Height	77
Seat Height	38

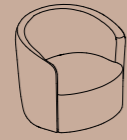

## Show 2

Width	87
Depth	73
Height	77
Seat Height	38

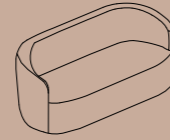

## Show 3

Width	188
Depth	73
Height	77
Seat Height	38

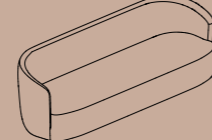

## Show 4

Width	250
Depth	73
Height	77
Seat Height	38

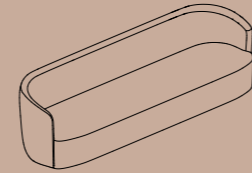

## Show 5

Width	285
Depth	73
Height	77
Seat Height	38

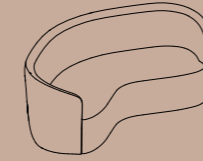

## Show 6

Width	204
Depth	73
Height	77
Seat Height	38



# Punto

## WORKING SPACES

01



02



03



01  
**Punto Armchair**

02  
**Punto Sofa**

03  
**Punto Sofa**



#workingspaces2024

# Punto

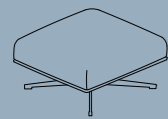

**Seating\_PUNTO\_Ottoman 70**

Width	70
Depth	65
Height	38

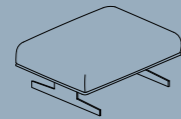

**Seating\_PUNTO\_Ottoman 90**

Width	90
Depth	65
Height	36

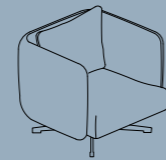

**Seating\_PUNTO\_Lounge 85**

Width	85
Depth	80
Height	79
Seat Height	38

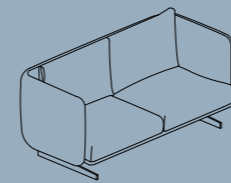

**Seating\_PUNTO\_Sofa 165**

Width	165
Depth	80
Height	79
Seat Height	38

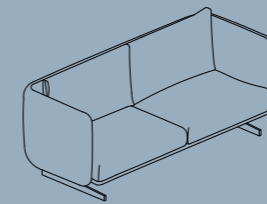

**Seating\_PUNTO\_Sofa 185**

Width	185
Depth	80
Height	79
Seat Height	38

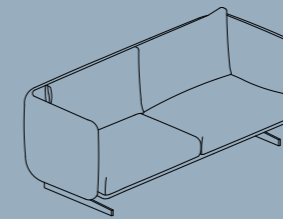

**Seating\_PUNTO\_Sofa 215**

Width	215
Depth	80
Height	79
Seat Height	38

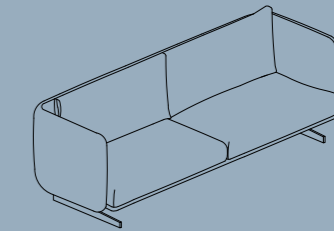

**Seating\_PUNTO\_Sofa 245**

Width	245
Depth	80
Height	79
Seat Height	38



#workspaces2024

# Rota

## WORKING SPACES

01



02



03



## WORKING SPACES

01  
Rota Lounge

02  
Rota Curved Sofa

03  
Rota Angular Sofa



#workingspaces2024

# Rota

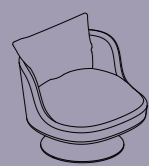

**Seating\_ROTА\_LNG\_PLEG**

Width 74  
Depth 70  
Height 60  
Seat Height 30

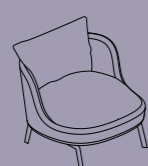

**Seating\_ROTА\_LNG\_SLEGV**

Width 74  
Depth 70  
Height 60  
Seat Height 30

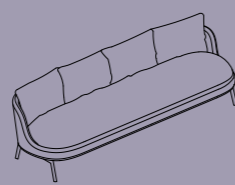

**Seating\_ROTА\_SFL235**

Width 235  
Depth 70  
Height 60  
Seat Height 30

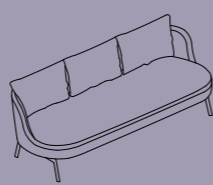

**Seating\_ROTА\_SFL195**

Width 195  
Depth 70  
Height 60  
Seat Height 30

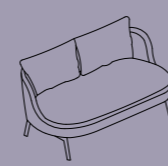

**Seating\_ROTА\_SFL135**

Width 135  
Depth 70  
Height 60  
Seat Height 30

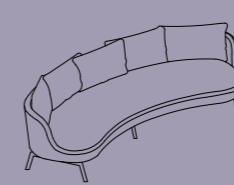

**Seating\_ROTА\_CRV240**

Width 240  
Depth 70  
Height 60  
Seat Height 30

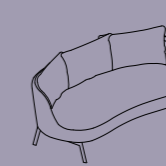

**Seating\_ROTА\_CRV160**

Width 160  
Depth 70  
Height 60  
Seat Height 30

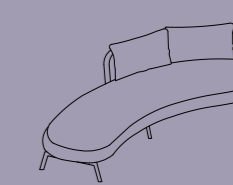

**Seating\_ROTА\_CRL240**

Width 240  
Depth 70  
Height 60  
Seat Height 30

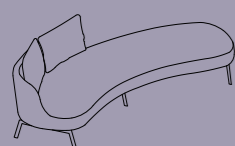

**Seating\_ROTА\_CRR240**

Width 240  
Depth 70  
Height 60  
Seat Height 30

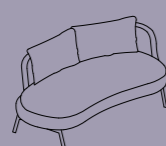

**Seating\_ROTА\_CRL160**

Width 160  
Depth 70  
Height 60  
Seat Height 30



**Seating\_ROTА\_CRR160**

Width 160  
Depth 70  
Height 60  
Seat Height 30

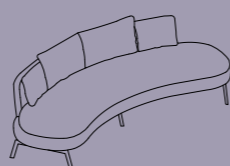

**Seating\_ROTА\_CRM240**

Width 240  
Depth 70  
Height 60  
Seat Height 30



**Seating\_ROTА\_CRM160**

Width 160  
Depth 70  
Height 60  
Seat Height 30

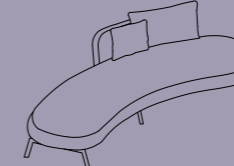

**Seating\_ROTА\_CCL240**

Width 240  
Depth 70  
Height 60  
Seat Height 30

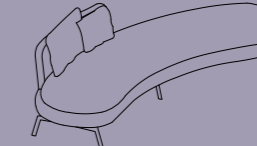

**Seating\_ROTА\_CCR240**

Width 240  
Depth 70  
Height 60  
Seat Height 30

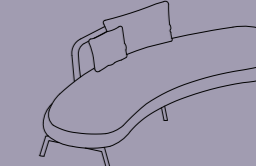

**Seating\_ROTА\_CCM240**

Width 240  
Depth 70  
Height 60  
Seat Height 30

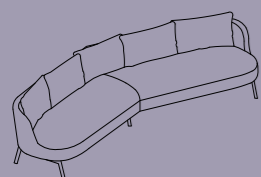

**Seating\_ROTА\_ANG290**

Width 290  
Depth 70  
Height 60  
Seat Height 30

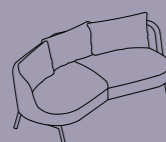

**Seating\_ROTА\_ANG175**

Width 175  
Depth 70  
Height 60  
Seat Height 30

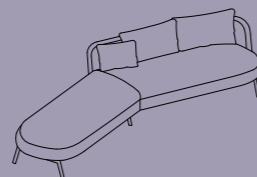

**Seating\_ROTА\_ANL290**

Width 290  
Depth 70  
Height 60  
Seat Height 30

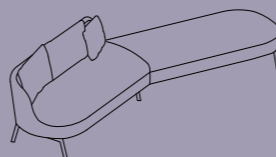

**Seating\_ROTА\_ANR290**

Width 290  
Depth 70  
Height 60  
Seat Height 30

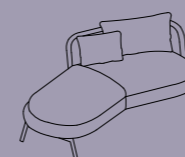

**Seating\_ROTА\_ANL175**

Width 175  
Depth 70  
Height 60  
Seat Height 30

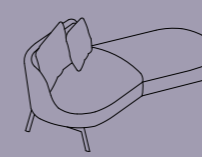

**Seating\_ROTА\_ANR175**

Width 175  
Depth 70  
Height 60  
Seat Height 30

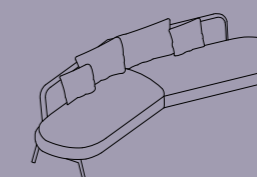

**Seating\_ROTА\_ANM290**

Width 290  
Depth 70  
Height 60  
Seat Height 30

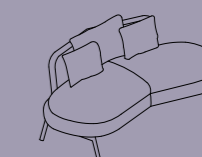

**Seating\_ROTА\_ANM175**

Width 175  
Depth 70  
Height 60  
Seat Height 30

🪵 🪑 🪴 🪴  
#workspaces2024



# Set

## WORKING SPACES



01

01  
Set Armchair



02  
Set Sofa Family



02



#workingspaces2024

# Set

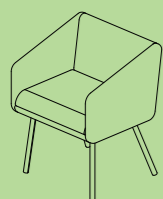

**Seating\_SET\_Chair**

Width	58
Depth	50
Height	73

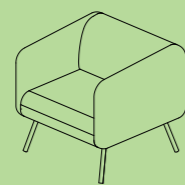

**Seating\_SET\_Lounge**

Width	50
Depth	60
Height	73

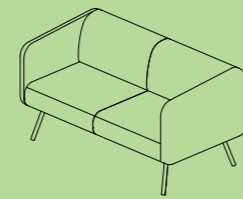

**Seating\_SET\_Sofa140**

Width	140
Depth	75
Height	73

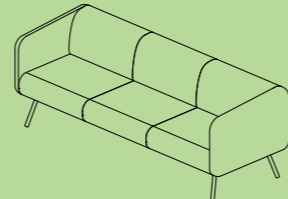

**Seating\_SET\_Sofa205**

Width	205
Depth	75
Height	73

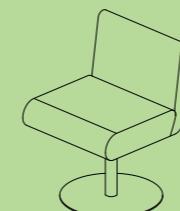

**SeatinSET\_Chair\_RT**

Width	50
Depth	60
Height	73

# Fly

01



02



03



01  
Fly Sofa Set

02  
Fly Sofa Set

03  
Fly Lounge

WORKING  
SPACES

  
#workingspaces2024

# Fly

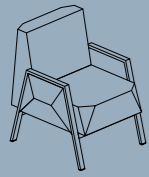

**Seating\_Fly\_LNG**

Width	64
Depth	80
Height	46

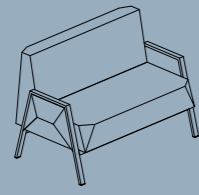

**Seating\_Fly\_SOF\_130**

Width	130
Depth	80
Height	46

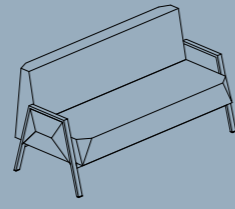

**Seating\_Fly\_SOF\_170**

Width	170
Depth	80
Height	46

# Meeting & Guest Chair

WORKING  
SPACES

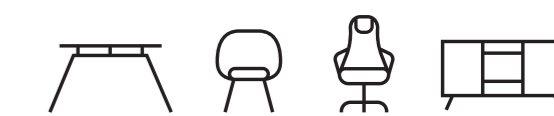

#workingspaces2024

# Jun

01



02



**WORKING  
SPACES**

01  
Jun Operational Chair

02  
Jun Operational Chair



#workingspaces2024

# Jun



**Jun Meeting Chair**

Width 93-105  
Depth 59  
Height 46-58



**Jun Meeting Chair**

Width 93  
Depth 59  
Height 43



#workspaces2024

# Clone

01



03



02



Space Styled,  
Work Perfected.

01  
Clone Operational Chair

02  
Clone Visitor Chair

03  
Clone Visitor Chair



#workingspaces2024

# Clone

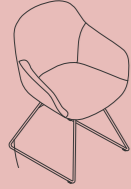

## Sled Base

Width	84
Depth	62
Height	47



## X Base

Width	84
Depth	62
Height	47

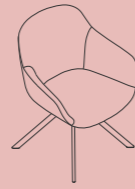

## Ellipse Base

Width	84
Depth	62
Height	47



## Office Base

Width	80-90
Depth	75
Height	42-52

# WORKING SPACES

01



02



03

# Boost

01  
Boost Operational Chair

02  
Boost Visitor Chair

03  
Boost Operational Chair



#workingspaces2024

# Boost



## Boost\_OPR

Width	75
Depth	72
Height	80



## Boost\_VSTS

Width	46
Depth	54
Height	84
Seat Height	50



## Boost\_VST4L

Width	48
Depth	55
Height	84
Seat Height	51



## Boost\_LNGU

Width	64
Depth	67
Height	84
Seat Height	46



## Boost\_VSTR

Width	63
Depth	66
Height	84
Seat Height	48



## Boost\_VSTU

Width	46
Depth	55
Height	84
Seat Height	48



#workingspaces2024

# Rota

01



02



03



Space Styled,  
Work Perfected.

01  
Rota Visitor Chair

02  
Rota Armchair

03  
Rota Visitor Chair



#workingspaces2024

# Rota

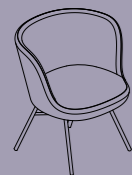

**Seating\_ROTACHR\_X**

Width	68
Depth	60
Height	75
Seat Height	40

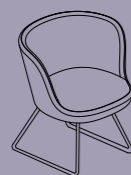

**Seating\_ROTACHR\_S**

Width	68
Depth	60
Height	75
Seat Height	40



**Seating\_ROTACHR\_R**

Width	68
Depth	60
Height	75
Seat Height	40



**Seating\_ROTACHR\_04**

Width	68
Depth	60
Height	75
Seat Height	40



**Seating\_ROTACHR\_05**

Width	68
Depth	30
Height	75
Seat Height	40

  
#workspaces2024



# Avensis

## WORKING SPACES

01



01  
Avensis Operational Chair

02



02  
Avensis Visitor Chair

03



03  
Avensis Visitor Chair



#workingspaces2024

# Avensis



## Avensis\_OPR

Width	65
Depth	55
Height	110
Seat Height	50



## Avensis\_VSTD5

Width	65
Depth	55
Height	110
Seat Height	50

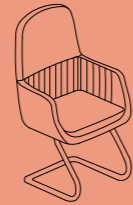

## Avensis\_VSTU

Width	65
Depth	55
Height	110
Seat Height	50



# Concorde

## WORKING SPACES

01



Space Styled,  
Work Perfected.

02



01  
Concorde Visitor Chair

02  
Concorde Visitor Chair



#workingspaces2024

# Concorde



**Concorde\_VST**

Width	67
Depth	48
Height	110
Seat Height	50



**Concorde\_OPR**

Width	67
Depth	48
Height	110
Seat Height	50



#workspaces2024

# Jully



01



02



03

Space Styled,  
Work Perfected.

01  
Jully Visitor Chair

02  
Jully Visitor Chair

03  
Jully Visitor Chair



#workingspaces2024

# Jully



**Jully\_VSTD5**

Width	70
Depth	60
Height	118
Seat Height	50



**Jully\_VSTU**

Width	70
Depth	60
Height	118
Seat Height	50



**Jully\_OPR**

Width	70
Depth	60
Height	118
Seat Height	50

# WORKING SPACES



# Silver

01  
Silver Manager Chair

02  
Slim Visitor Chair

# Silver

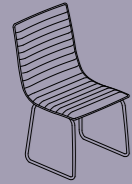

**Silver\_VST**

Width	55
Depth	62
Height	98
Seat Height	50



**Silver\_OPR**

Width	58
Depth	67
Height	110
Seat Height	50

# Odissea

01



02



Space Styled,  
Work Perfected.

01  
Odissea Visitor Chair

02  
Odissea Visitor Chair



#workspaces2024

# Odissea

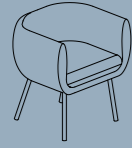

## Seating\_ODISSEA\_Chair\_4leg

Width	65
Depth	70
Height	77
Seat Height	45

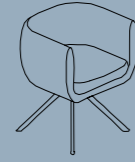

## Seating\_ODISSEA\_Chair\_Rotate

Width	65
Depth	70
Height	77
Seat Height	45

# Set

01



02



Space Styled,  
Work Perfected.

01  
Set Visitor Chair

02  
Set Visitor Chair



#workspaces2024

# Set

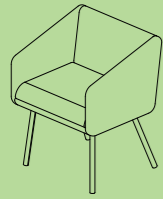

**Seating\_SET\_Chair**

Width 58  
Depth 50  
Height 73

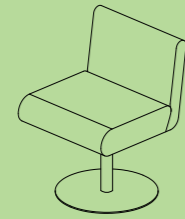

**Seatin\_SET\_Chair\_RT**

Width 50  
Depth 60  
Height 73

# Meeting & Guest Chair

WORKING  
SPACES



#workingspaces2024

# Jun

01



02



**WORKING  
SPACES**

01  
Jun Operational Chair

02  
Jun Operational Chair



#workingspaces2024

# Jun



**Jun Meeting Chair**

Width 93-105  
Depth 59  
Height 46-58

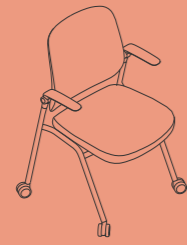

**Jun Meeting Chair**

Width 93  
Depth 59  
Height 43



#workspaces2024

# Clone

01



01

Clone Operational Chair

02



02

Clone Visitor Chair

03



03

Clone Visitor Chair

Space Styled,  
Work Perfected.



#workingspaces2024

# Clone

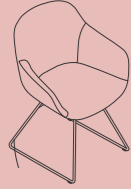

## Sled Base

Width	84
Depth	62
Height	47



## X Base

Width	84
Depth	62
Height	47

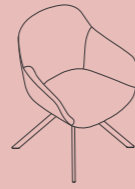

## Ellipse Base

Width	84
Depth	62
Height	47



## Office Base

Width	80-90
Depth	75
Height	42-52

# WORKING SPACES

01



02



03

# Boost

01  
Boost Operational Chair

02  
Boost Visitor Chair

03  
Boost Operational Chair



#workingspaces2024

# Boost



## Boost\_OPR

Width	75
Depth	72
Height	80



## Boost\_VSTS

Width	46
Depth	54
Height	84
Seat Height	50



## Boost\_VST4L

Width	48
Depth	55
Height	84
Seat Height	51



## Boost\_LNGU

Width	64
Depth	67
Height	84
Seat Height	46



## Boost\_VSTR

Width	63
Depth	66
Height	84
Seat Height	48



## Boost\_VSTU

Width	46
Depth	55
Height	84
Seat Height	48



#workingspaces2024

# Rota

01



02



03



Space Styled,  
Work Perfected.

01  
Rota Visitor Chair

02  
Rota Armchair

03  
Rota Visitor Chair



#workingspaces2024

# Rota

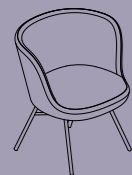

**Seating\_ROTACHR\_X**

Width	68
Depth	60
Height	75
Seat Height	40

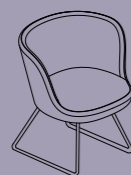

**Seating\_ROTACHR\_S**

Width	68
Depth	60
Height	75
Seat Height	40



**Seating\_ROTACHR\_R**

Width	68
Depth	60
Height	75
Seat Height	40



**Seating\_ROTACHR\_04**

Width	68
Depth	60
Height	75
Seat Height	40



**Seating\_ROTACHR\_05**

Width	68
Depth	30
Height	75
Seat Height	40

  
#workspaces2024



# Avensis

## WORKING SPACES

01



01  
Avensis Operational Chair

02



02  
Avensis Visitor Chair

03



03  
Avensis Visitor Chair



#workingspaces2024

# Avensis



## Avensis\_OPR

Width	65
Depth	55
Height	110
Seat Height	50



## Avensis\_VSTD5

Width	65
Depth	55
Height	110
Seat Height	50

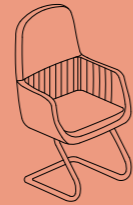

## Avensis\_VSTU

Width	65
Depth	55
Height	110
Seat Height	50



# Concorde

## WORKING SPACES

01



Space Styled,  
Work Perfected.

02



01  
Concorde Visitor Chair

02  
Concorde Visitor Chair



#workingspaces2024

# Concorde



**Concorde\_VST**

Width	67
Depth	48
Height	110
Seat Height	50



**Concorde\_OPR**

Width	67
Depth	48
Height	110
Seat Height	50



# Jully



01



02



03

Space Styled,  
Work Perfected.

01  
Jully Visitor Chair

02  
Jully Visitor Chair

03  
Jully Visitor Chair



#workingspaces2024

# Jully



**Jully\_VSTD5**

Width	70
Depth	60
Height	118
Seat Height	50



**Jully\_VSTU**

Width	70
Depth	60
Height	118
Seat Height	50



**Jully\_OPR**

Width	70
Depth	60
Height	118
Seat Height	50

# WORKING SPACES



# Silver

01  
Silver Manager Chair

02  
Slim Visitor Chair

# Silver

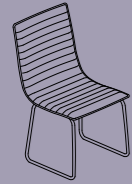

**Silver\_VST**

Width	55
Depth	62
Height	98
Seat Height	50



**Silver\_OPR**

Width	58
Depth	67
Height	110
Seat Height	50

# Odissea

01



Space Styled,  
Work Perfected.

02



01  
Odissea Visitor Chair

02  
Odissea Visitor Chair



#workspaces2024

# Odissea

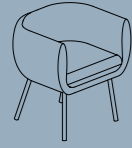

## Seating\_ODISSEA\_Chair\_4leg

Width	65
Depth	70
Height	77
Seat Height	45

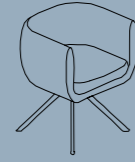

## Seating\_ODISSEA\_Chair\_Rotate

Width	65
Depth	70
Height	77
Seat Height	45

# Set

01



02



Space Styled,  
Work Perfected.

01  
Set Visitor Chair

02  
Set Visitor Chair



#workspaces2024

# Set

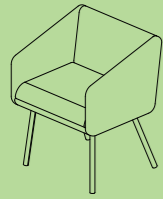

**Seating\_SET\_Chair**

Width 58  
Depth 50  
Height 73

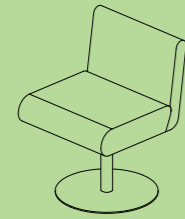

**Seatin\_SET\_Chair\_RT**

Width 50  
Depth 60  
Height 73

# Bar Chairs

WORKING  
SPACES



#workingspaces2024



01



02

01  
Lucky Bar Chair

02  
Lucky Bar Chair

Lucky



#workingspaces2024

# Lucky



**Lucky\_Bar\_Withback**

Width	67
Depth	70
Height	102-116



**Lucky\_Bar\_Withoutback**

Width	67
Depth	70
Height	77

# WORKING SPACES

01



02



# Champinon

01  
Champinon Chair

# Champinon

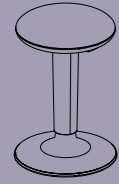

**Champinon\_Bar**

Depth      Ø35  
Height    55-73



#workspaces2024

# Rota

## WORKING SPACES



01



02



03

01  
Rota Bar Chair

02  
Rota Bar Chair

03  
Rota Bar Chair



#workingspaces2024

# Rota

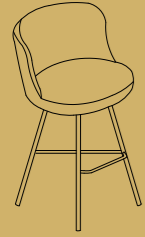

**Seating\_Rota\_BAR\_X**

Width	52
Depth	52
Height	95



**Seating\_Rota\_BAR\_S**

Width	52
Depth	52
Height	95



**Seating\_Rota\_BAR\_G**

Width	52
Depth	52
Height	95



# Boost

## WORKING SPACES

01



02



03



01  
Boost Bar Chair

02  
Boost Bar Chair

03  
Boost Bar Chair



#workingspaces2024

# Boost



**Boost\_Bar\_X**

Width	46
Depth	54
Height	95



**Boost\_Bar\_Sled**

Width	46
Depth	54
Height	95



**Boost\_Bar\_Gaslift**

Width	46
Depth	54
Height	95



#workingspaces2024

# Cartello

## WORKING SPACES

01



02



03



01  
Cartello Bar Chair

02  
Cartello Bar Chair

03  
Cartello Bar Chair



#workingspaces2024



#workspaces2024

# Jun

## WORKING SPACES



01



02

Space Styled,  
Work Perfected.

01  
Jun Bar Chair

02  
Jun Bar Chair



#workingspaces2024

# Jun

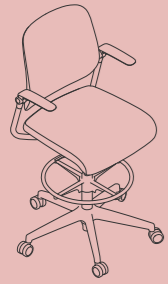

## Jun Draft Chair

Width	115-127
Depth	68
Height	70-82

# Training - Seminar Chair

WORKING  
SPACES



#workingspaces2024

# Jun

## WORKING SPACES

01



02



01  
Jun Operational Chair

02  
Jun Operational Chair



#workingspaces2024

# Jun

## WORKING SPACES

01



02



03



01  
Jun Operational Chair

02  
Jun Operational Chair

03  
Jun Operational Chair



#workingspaces2024

# Jun

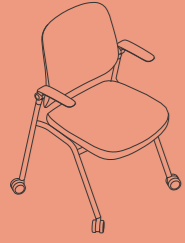

**Jun Meeting Chair**

Width 93  
Depth 59  
Height 43

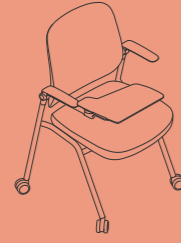

**Jun Seminar Chair**

Width 93  
Depth 59  
Height 43



#workspaces2024

# Pouf

WORKING  
SPACES

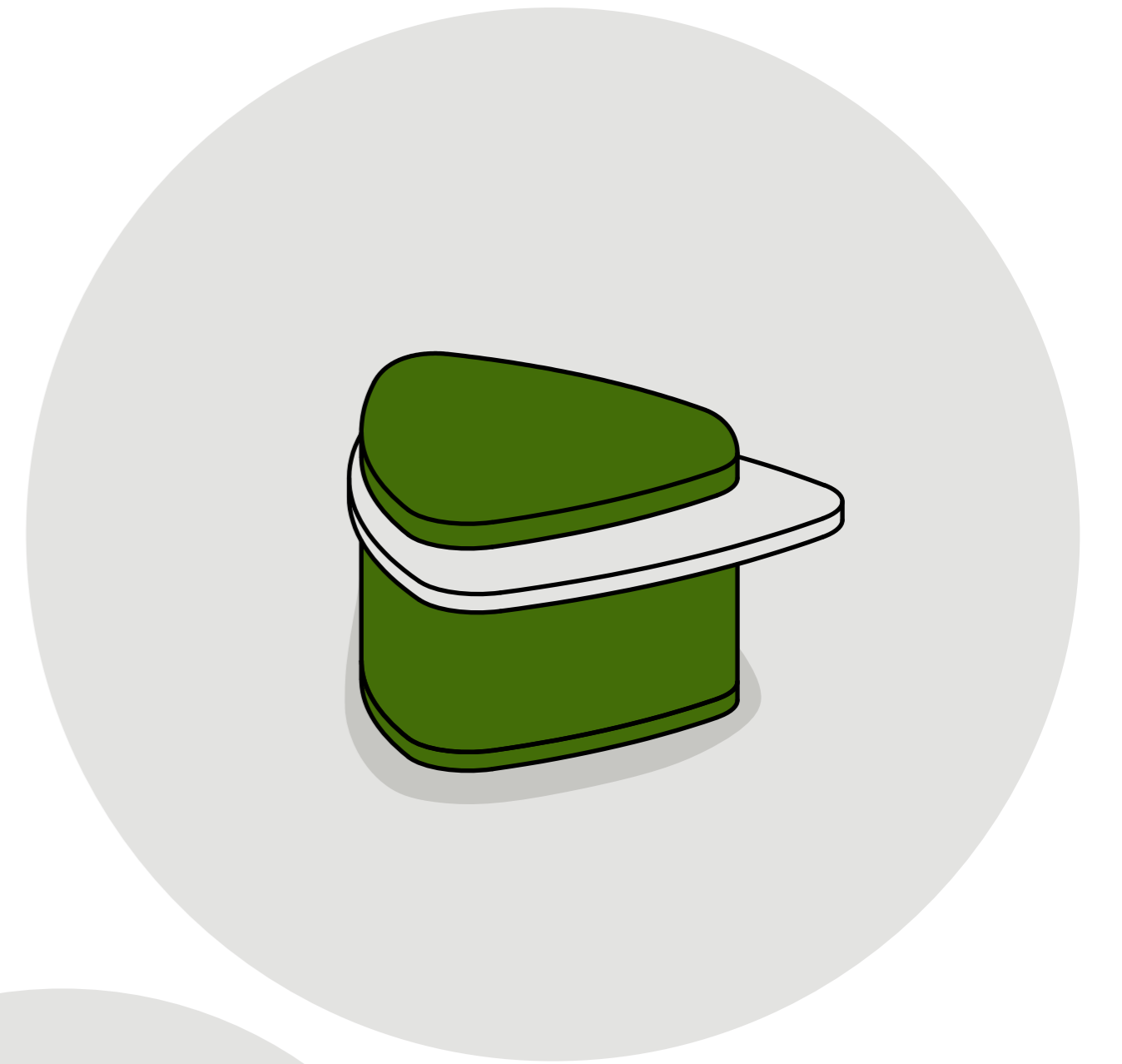

#workspaces2024

# Opto

## WORKING SPACES



01  
Opto Pouf



02  
Opto Pouf



03  
Opto Pouf

Space Styled,  
Work Perfected.



#workingspaces2024

# Opto

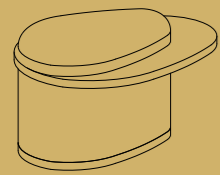

**Opto Puf 1**

Width 80  
Depth 60  
Height 48

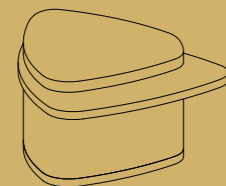

**Opto Puf 2**

Width 77  
Depth 73  
Height 48

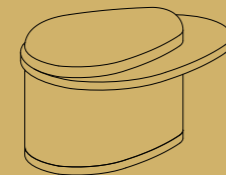

**Opto Puf 3**

Width 77  
Depth 57  
Height 48

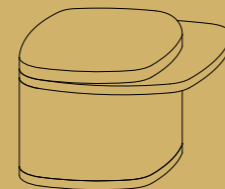

**Opto Puf 4**

Width 76  
Depth 64  
Height 48

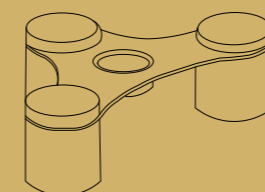

**Opto Puf 5**

Width 131  
Depth 81  
Height 48

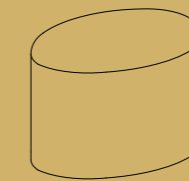

**Opto Puf 6**

Width 65  
Depth 45  
Height 46

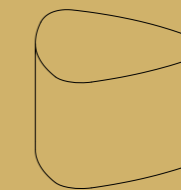

**Opto Puf 7**

Width 59  
Depth 56  
Height 46

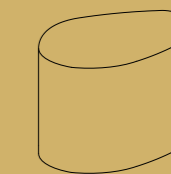

**Opto Puf 8**

Width 59  
Depth 40  
Height 46

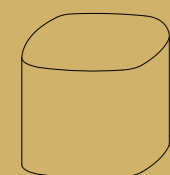

**Opto Puf 9**

Width 57  
Depth 48  
Height 46

# Mitte

## WORKING SPACES

01



02



01  
Mitte Pouf

# Mitte

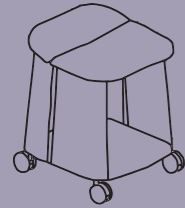

## Mitte Puf

Width	40
Depth	40
Height	50

# Medy

## WORKING SPACES

01



02



01  
Medy Pouf



#workingspaces2024

# Medy

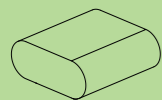

## Seating\_MEDY\_PFL9090

Width	90
Depth	90
Height	40
Seat Height	40

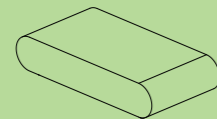

## Seating\_MEDY\_PFL90180

Width	180
Depth	90
Height	40
Seat Height	40

# Joker

WORKING  
SPACES



01

**Joker Pouf**



#workingspaces2024

# Joker

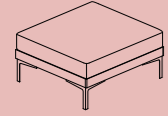

## Seating\_JOKER\_PUF80

Width	80
Depth	73
Height	40
Seat Height	25

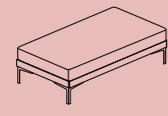

## Seating\_JOKER\_PUF136

Width	136
Depth	73
Height	40
Seat Height	25

# Origo

## WORKING SPACES

01



02



03



Space Styled,  
Work Perfected.

01  
Origo Pouf

02  
Origo Pouf & Coffee Table

03  
Origo Pouf



#workingspaces2024

# Origo

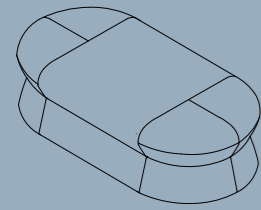

**SEATING\_ORIGO\_160X80XH45**

Width 160  
Depth 80  
Height 45

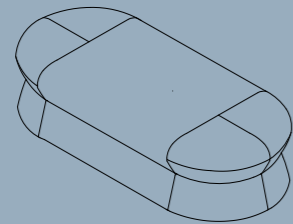

**SEATING\_ORIGO\_180X80XH45**

Width 180  
Depth 80  
Height 45

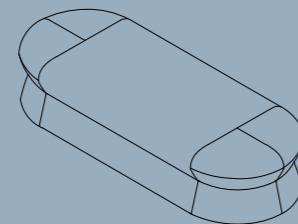

**SEATING\_ORIGO\_210X80XH45**

Width 210  
Depth 80  
Height 45

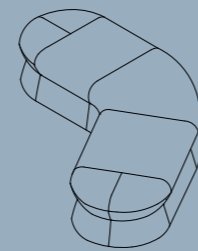

**SEATING\_ORIGO\_240X185XH45**

Width 240  
Depth 185  
Height 45

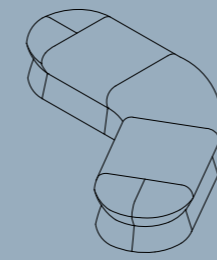

**SEATING\_ORIGO\_260X185XH45**

Width 260  
Depth 185  
Height 45

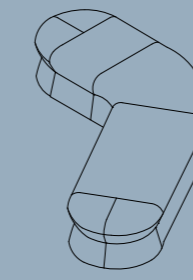

**SEATING\_ORIGO\_265X228XH45**

Width 265  
Depth 228  
Height 45

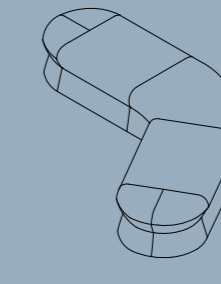

**SEATING\_ORIGO\_290X201XH45**

Width 290  
Depth 201  
Height 45

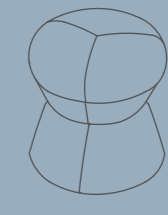

**SEATING\_ORIGO\_R43H45**

Width 43  
Depth 43  
Height 45

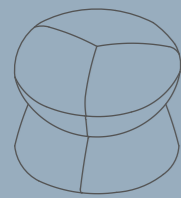

**SEATING\_ORIGO\_R60H45**

Width 60  
Depth 60  
Height 45

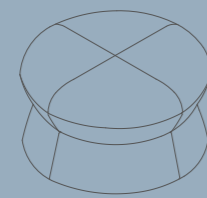

**SEATING\_ORIGO\_R80H45**

Width 80  
Depth 80  
Height 45

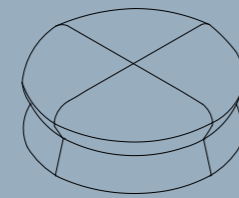

**SEATING\_ORIGO\_R120H45**

Width 120  
Depth 120  
Height 45

# Cage Pouf

WORKING SPACES



01



02

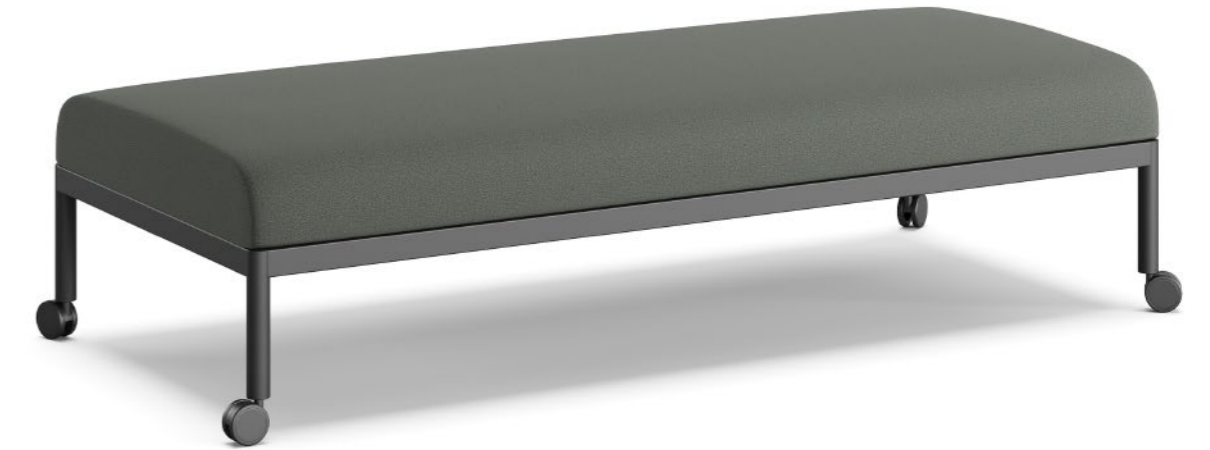

03

Space Styled,  
Work Perfected.

01  
Cage Pouf

02  
Cage Pouf

03  
Cage Pouf



#workingspaces2024

# Cage Pouf

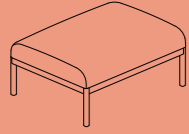

**Seating\_CageLounge\_PUF\_93**

Width 93  
Depth 93

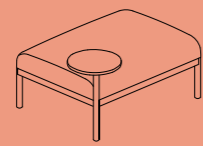

**Seating\_CageLounge\_PUF\_93\_STL**

Width 93  
Depth 93

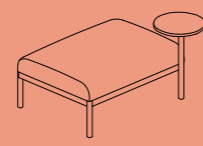

**Seating\_CageLounge\_PUF\_93\_STR**

Width 93  
Depth 93

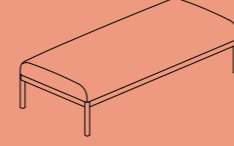

**Seating\_CageLounge\_PUF\_161**

Width 93  
Depth 93

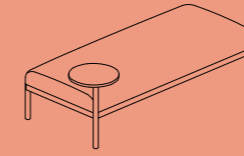

**Seating\_CageLounge\_PUF\_161\_STL**

Width 93  
Depth 93

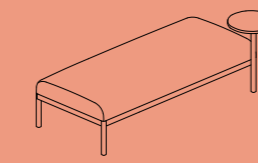

**Seating\_CageLounge\_PUF\_161\_STR**

Width 93

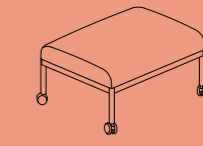

**Seating\_CageLounge\_PUF\_M\_93**

Width 93

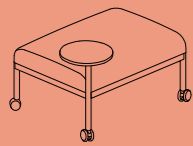

**Seating\_CageLounge\_PUF\_M\_93\_STL**

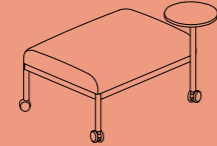

**Seating\_CageLounge\_PUF\_M\_93\_STR**

Width 93

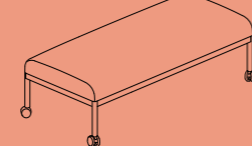

**Seating\_CageLounge\_PUF\_M\_161**

Width 93

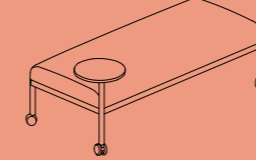

**Seating\_CageLounge\_PUF\_M\_161\_STL**

Width 93

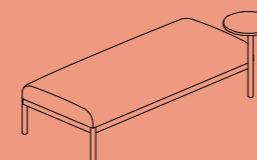

**Seating\_CageLounge\_PUF\_M\_161\_STR**

Width 93

# Punto

## WORKING SPACES

01



01  
Punto Pouf



#workingspaces2024

# Punto

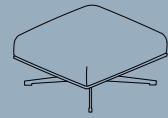

**Seating\_PUNTO\_Ottoman 70**

Width	70
Depth	65
Height	38

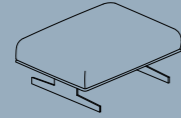

**Seating\_PUNTO\_Ottoman 90**

Width	90
Depth	65
Height	36

# Coffee Tables

WORKING  
SPACES

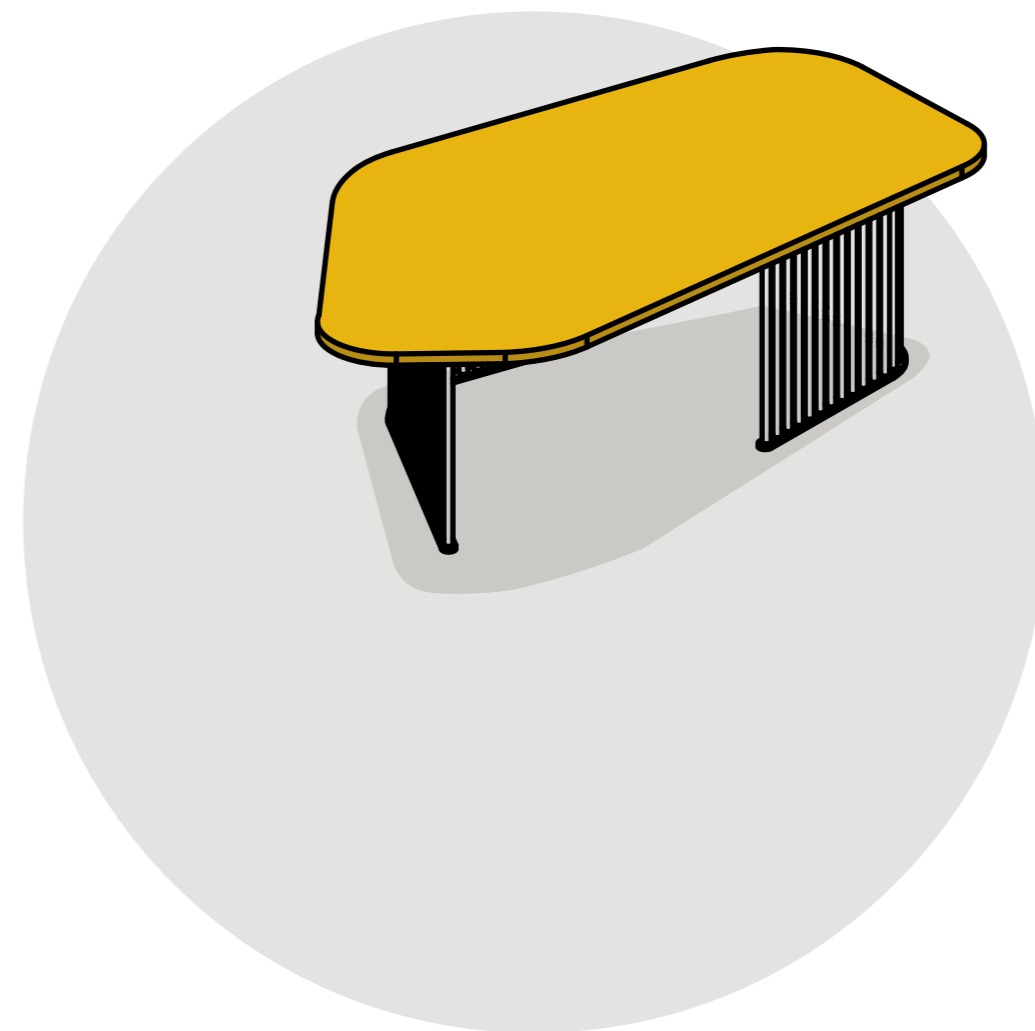
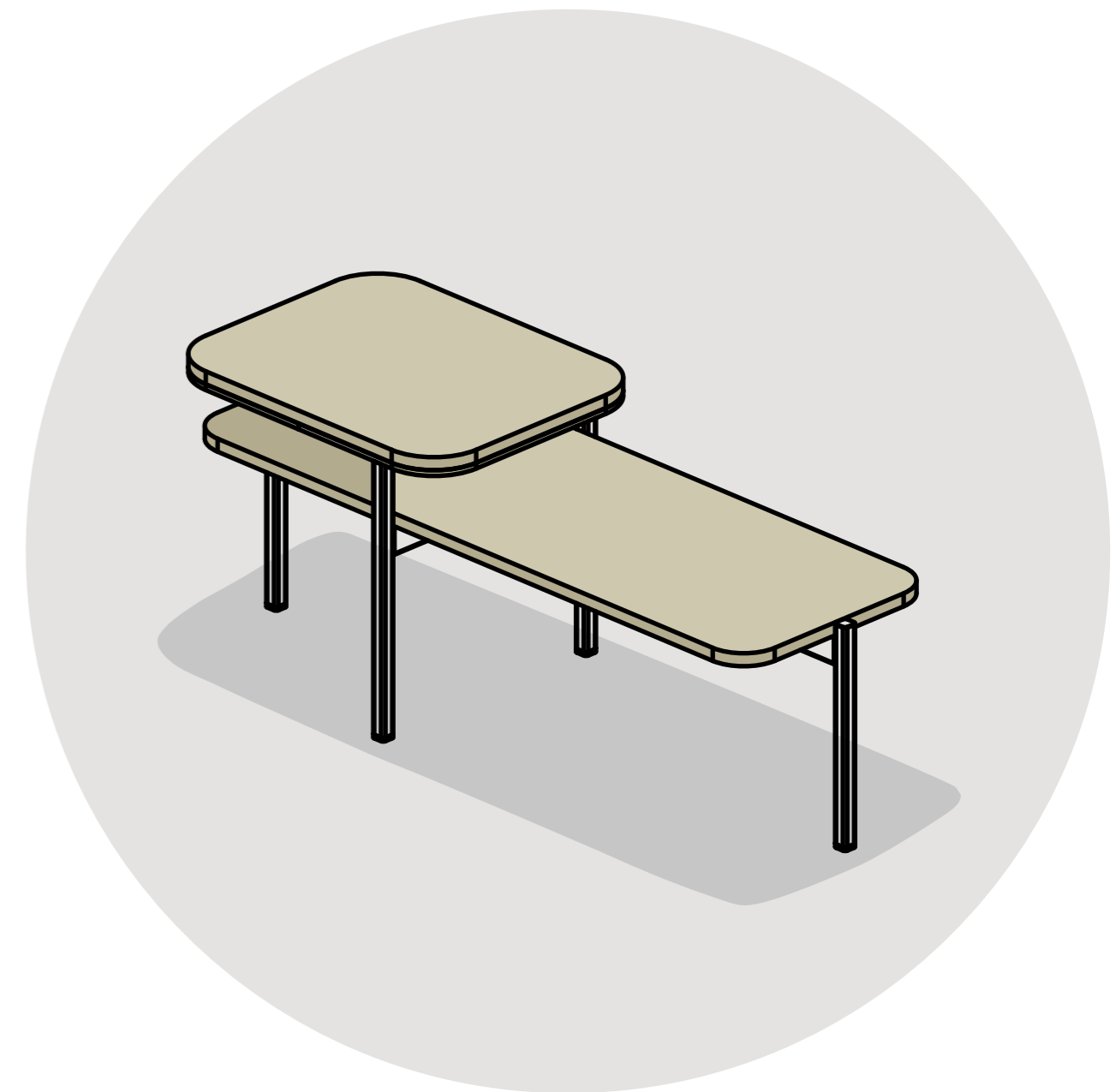

#workspaces2024

# Deluxe

## WORKING SPACES

01



01  
Deluxe Coffee Table

02



02  
Deluxe Coffee Table

03



03  
Deluxe Coffee Table



#workingspaces2024

# Deluxe

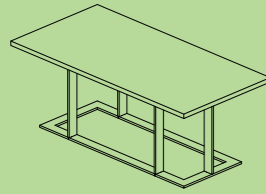

**COFFE TABLE\_Deluxe\_9045H35**

Width 90  
Depth 45  
Height 35

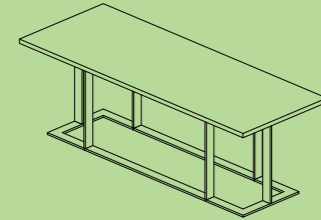

**COFFE TABLE\_Deluxe\_12045H40**

Width 120  
Depth 45  
Height 40

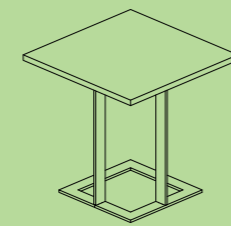

**COFFE TABLE\_Deluxe\_4545H45**

Width 45  
Depth 45  
Height 45

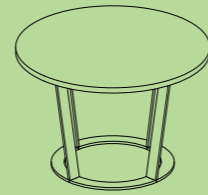

**COFFE TABLE\_Deluxe\_Ø60 H40**

Dim Ø60  
Height 40

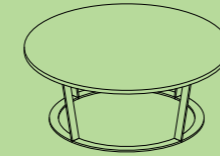

**COFFE TABLE\_Deluxe\_Ø90H35**

Dim Ø90  
Height 35

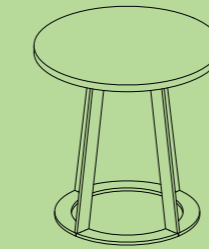

**COFFE TABLE\_Deluxe\_Ø45 H45**

Dim Ø45  
Height 45

# Dublex

01



02



03



Space Styled,  
Work Perfected.

01  
Dublex Coffee Table

02  
Dublex Coffee Table

03  
Dublex Coffee Table



#workspaces2024

# Dublex

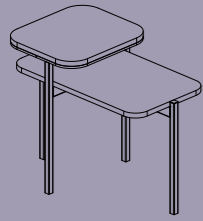

**COFFE TABLE\_Dublex\_6338H51**

Width 63  
Depth 38  
Height 51

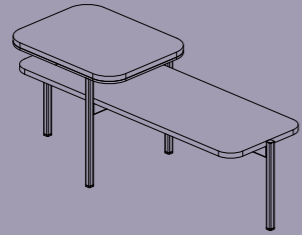

**COFFE TABLE\_Dublex\_10348H41**

Width 103  
Depth 38  
Height 41

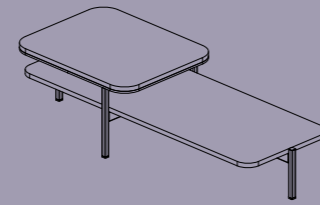

**COFFE TABLE\_Dublex\_10348H41**

Width 123  
Depth 48  
Height 30

# Motto

## WORKING SPACES

01



02



03



Space Styled,  
Work Perfected.

01  
Motto Coffee Table

02  
Motto Coffee Table

03  
Motto Coffee Table



#workingspaces2024

# Motto

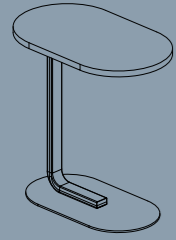

## COFFE TABLE\_Motto\_5030H50

Width 50  
Depth 30  
Height 50

# Pipe

01



02



03



Space Styled,  
Work Perfected.

01  
Pipe Coffee Table

02  
Pipe Coffee Table

03  
Pipe Coffee Table

# Pipe

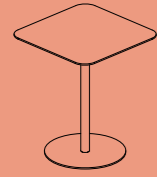

**COFFEE TABLE\_Pipe\_4040H48**

Width 40  
Depth 40  
Height 48

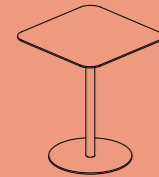

**COFFEE TABLE\_PipeMetal\_4040H48**

Width 40  
Depth 40  
Height 48

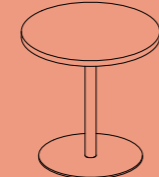

**COFFEE TABLE\_Pipe\_Ø40H40**

Depth Ø:40  
Height 40

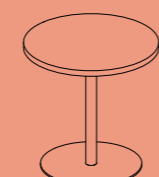

**COFFEE TABLE\_PipeMetal\_Ø40H40**

Depth Ø:40  
Height 40

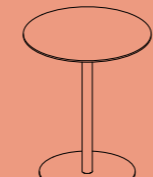

**COFFEE TABLE\_Pipe\_Ø40H48**

Depth Ø:40  
Height 48

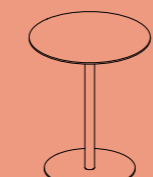

**COFFEE TABLE\_PipeMetal\_Ø40H48**

Depth Ø:40  
Height 48

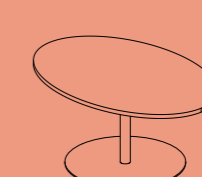

**COFFEE TABLE\_Pipe\_9060H40**

Width 90  
Depth 60  
Height 40

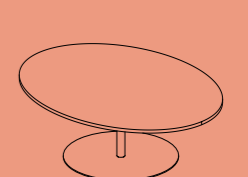

**COFFEE TABLE\_Pipe\_12090H40**

Width 120  
Depth 90  
Height 40

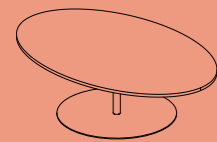

**COFFEE TABLE\_Pipe\_14090H40**

Width 140  
Depth 90  
Height 40

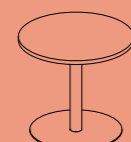

**COFFEE TABLE\_Pipe\_Ø50H45**

Depth Ø50  
Height 45

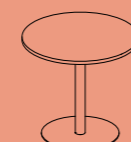

**COFFEE TABLE\_Pipe\_Ø60H55**

Depth Ø60  
Height 55



**COFFEE TABLE\_Pipe\_Ø50H55**

Depth Ø50  
Height 55

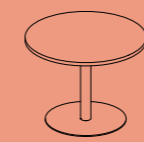

**COFFEE TABLE\_Pipe\_Ø60H45**

Depth Ø60  
Height 45

# WORKING SPACES

01



# Portfoy

01  
Portfoy Coffee Table



#workingspaces2024

# Portfoy

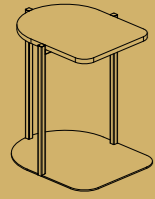

**COFFE TABLE\_Portfoy\_4840H50**

Width	48
Depth	40
Height	50

# Prime

## WORKING SPACES



01



02

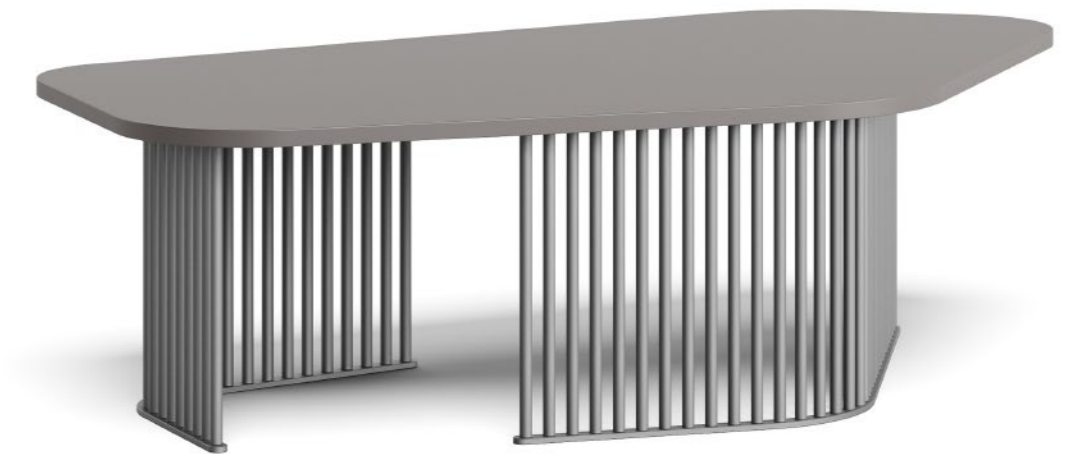

03

Space Styled,  
Work Perfected.

01  
Prime Coffee Table

02  
Prime Coffee Table

03  
Prime Coffee Table



#workingspaces2024

# Prime

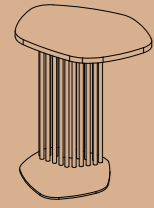

**COFFE TABLE\_Prime1\_4535H50**

Width 45  
Depth 35  
Height 50

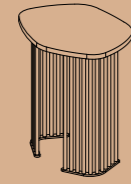

**COFFE TABLE\_Prime2\_4535H50**

Width 45  
Depth 35  
Height 50

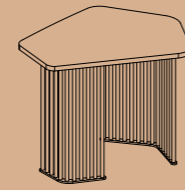

**COFFE TABLE\_Prime3\_6050H50**

Width 60  
Depth 50  
Height 50



**COFFE TABLE\_Prime4\_6050H50**

Width 60  
Depth 50  
Height 50

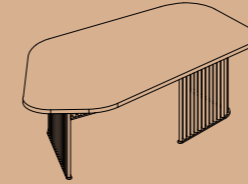

**COFFE TABLE\_Prime5\_12065H35**

Width 120  
Depth 65  
Height 35

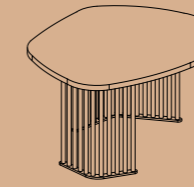

**COFFE TABLE\_Prime6\_6050H35**

Width 60  
Depth 50  
Height 35

# Stone

01



Space Styled,  
Work Perfected.

01  
Stone Coffee Table

# WORKING SPACES

03



02



02  
Stone Coffee Table

03  
Stone Coffee Table



#workingspaces2024

# Stone

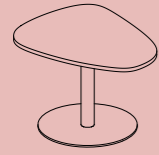

**COFFE TABLE\_Stone\_7055H45**

Width 70  
Depth 55  
Height 45

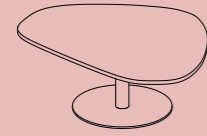

**COFFE TABLE\_Stone\_9570H35**

Width 95  
Depth 70  
Height 35

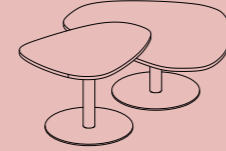

**COFFE TABLE\_Stone\_95125H45**

Width 95  
Depth 125  
Height 45

# WORKING SPACES

01



02



# Geo

01  
Geo Coffee Table

02  
Geo Coffee Table



#workingspaces2024

# Geo

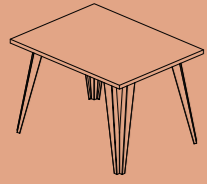

## COFFEE TABLE\_Geo\_6550H43

Width	65
Depth	50
Height	43

# WORKING SPACES

01



02



# Planet

01  
Planet Coffee Table

02  
Planet Coffee Table



#workingspaces2024

# Planet

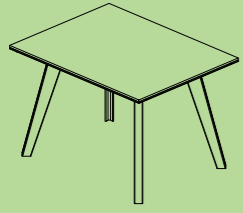

**COFFEE TABLE\_Planet\_6550H45**

Width	65
Depth	50
Height	45

WORKING SPACES

01



02



PlanetR

01  
PlanetR Coffee Table

02  
PlanetR Coffee Table



#workingspaces2024

# PlanetR

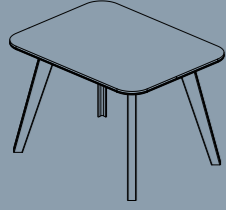

**COFFEE TABLE\_PlanetR\_6550H45**

Width	65
Depth	50
Height	45

# WORKING SPACES

01



02



# Polo

01  
Polo Coffee Table

02  
Polo Coffee Table

# Polo

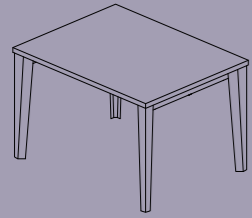

## COFFEE TABLE\_Polo\_6550H42

Width	65
Depth	50
Height	42

# WORKING SPACES

01



02



# Slide

01  
Slide Coffee Table

02  
Slide Coffee Table



#workingspaces2024

# Slide

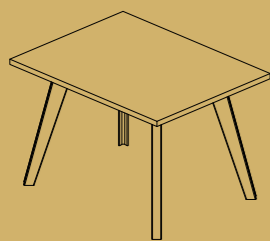

**COFFEE TABLE\_Slide\_6550H45**

Width	65
Depth	50
Height	45

# WORKING SPACES

01



02



# Steel

01  
Steel Coffee Table

02  
Steel Coffee Table



#workingspaces2024

# Steel

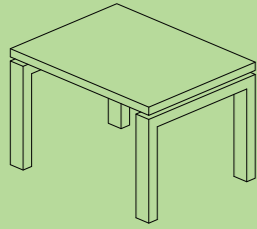

**COFFEE TABLE\_Steel\_6550H45**

Width	65
Depth	50
Height	45

# Origo

## WORKING SPACES

01



Space Styled,  
Work Perfected.



02

01  
Origo Coffee Table

02  
Origo Coffee Table

03  
Origo Coffee Table

03



#workingspaces2024

# Origo

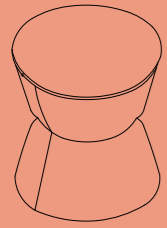

**COFFEETABLE\_ORIGO\_R42H46**

Width 42  
Depth 42  
Height 46

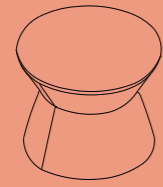

**COFFEETABLE\_ORIGO\_R45H37**

Width 45  
Depth 45  
Height 37

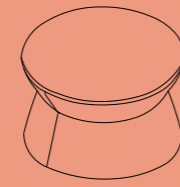

**COFFEETABLE\_ORIGO\_R60H37**

Width 60  
Depth 60  
Height 37

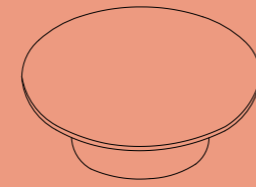

**COFFEETABLE\_ORIGO\_R70H25**

Width 70  
Depth 70  
Height 25

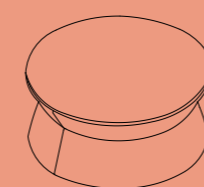

**COFFEETABLE\_ORIGO\_R80H37**

Width 80  
Depth 80  
Height 37

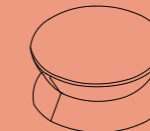

**COFFETABLE\_ORIGO\_R60H28**

Width 60  
Depth 60  
Height 28

# Reception Desk

WORKING  
SPACES

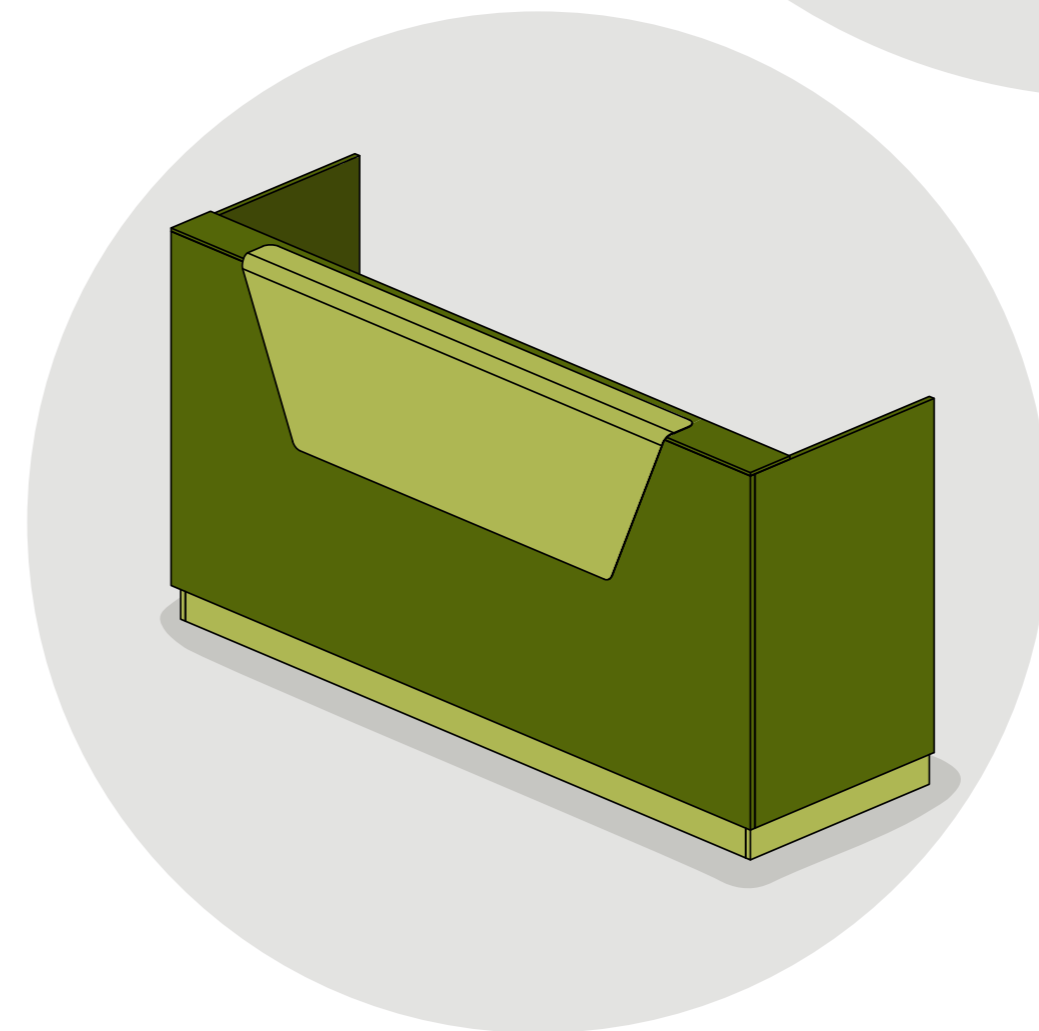
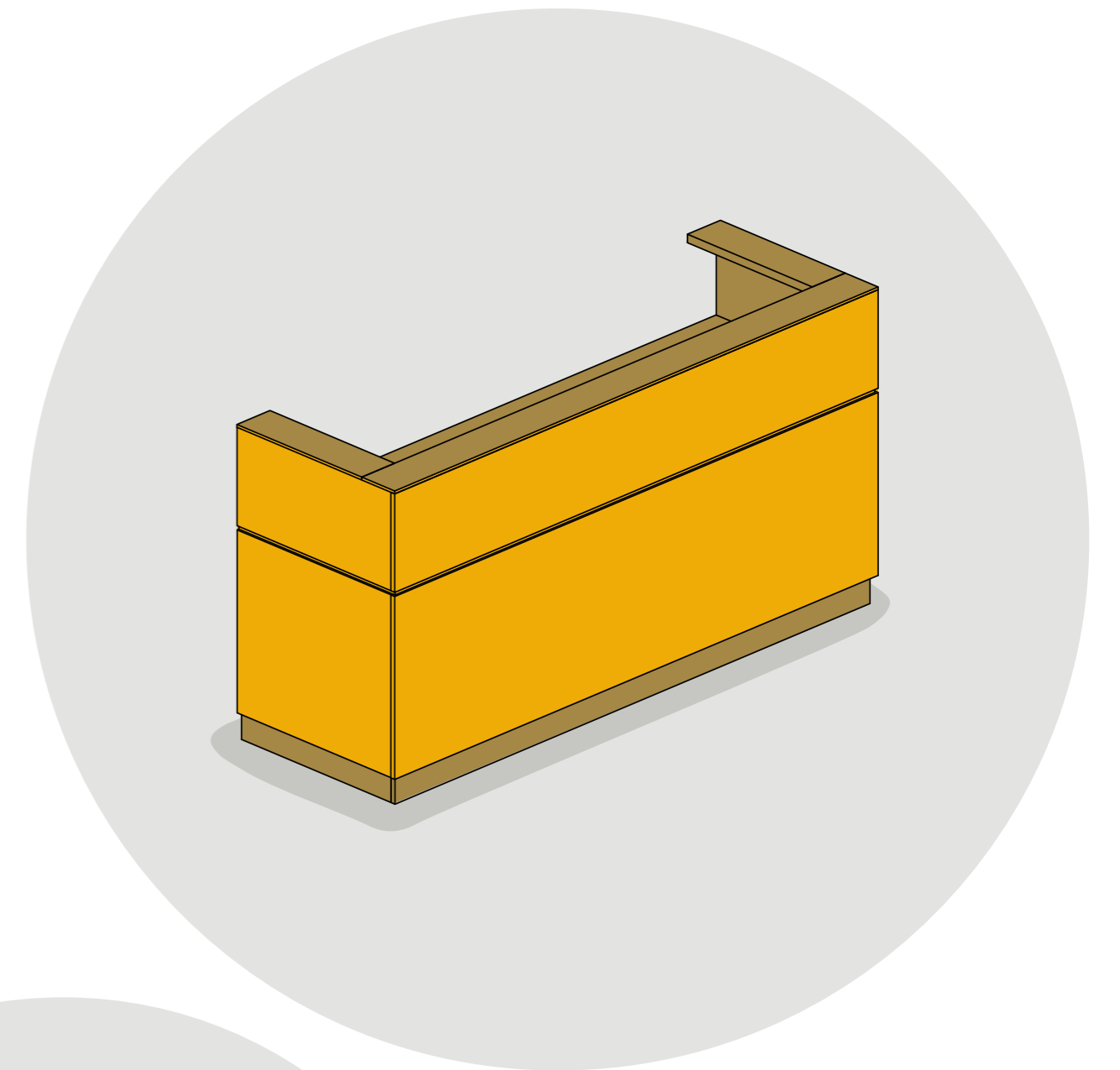

#workspaces2024

WORKING SPACES

01



02



Daisy

01  
Daisy Reception Desk



#workspaces2024

# Daisy

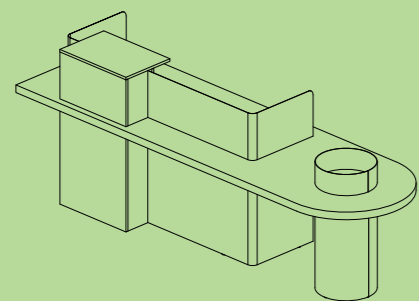

## Daisy\_Bank300

Width	300
Depth	90
Height	110

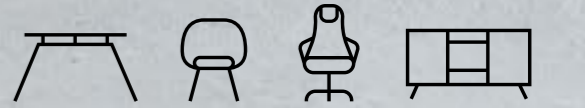

#workspaces2024

# Golf

## WORKING SPACES

01



02



Space Styled,  
Work Perfected.

01  
Golf Reception Desk



#workspaces2024

# Golf

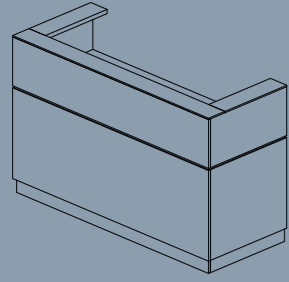

**Golf\_Bank180**

Width 180  
Depth 72  
Height 105

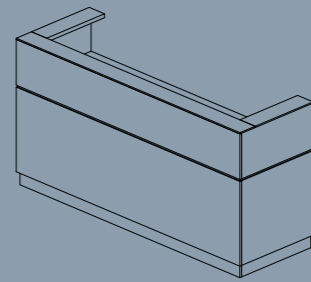

**Golf\_Bank220**

Width 220  
Depth 72  
Height 105

# WORKING SPACES

01



02



03



# Riva

01  
Riva Reception Desk



#workingspaces2024

# Riva

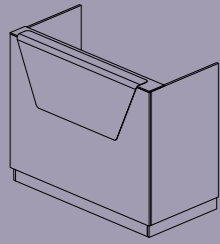

## Riva\_Bank140

Width 140  
Depth 70  
Height 105

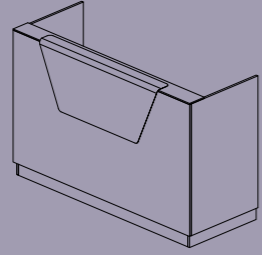

## Riva\_Bank180

Width 180  
Depth 70  
Height 105

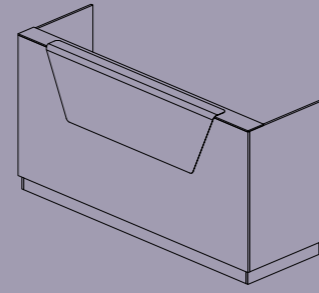

## Riva\_Bank220

Width 220  
Depth 70  
Height 105

# Dividers

WORKING  
SPACES

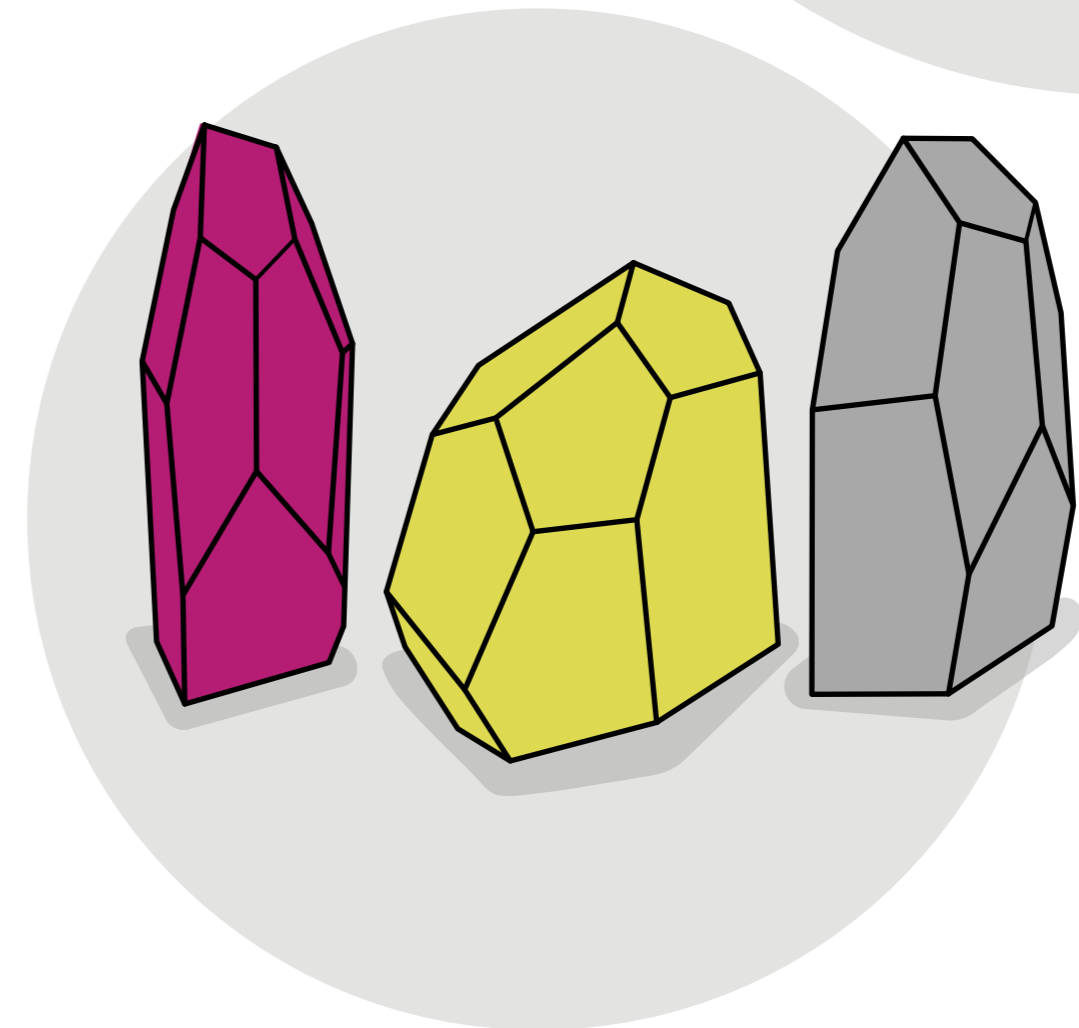
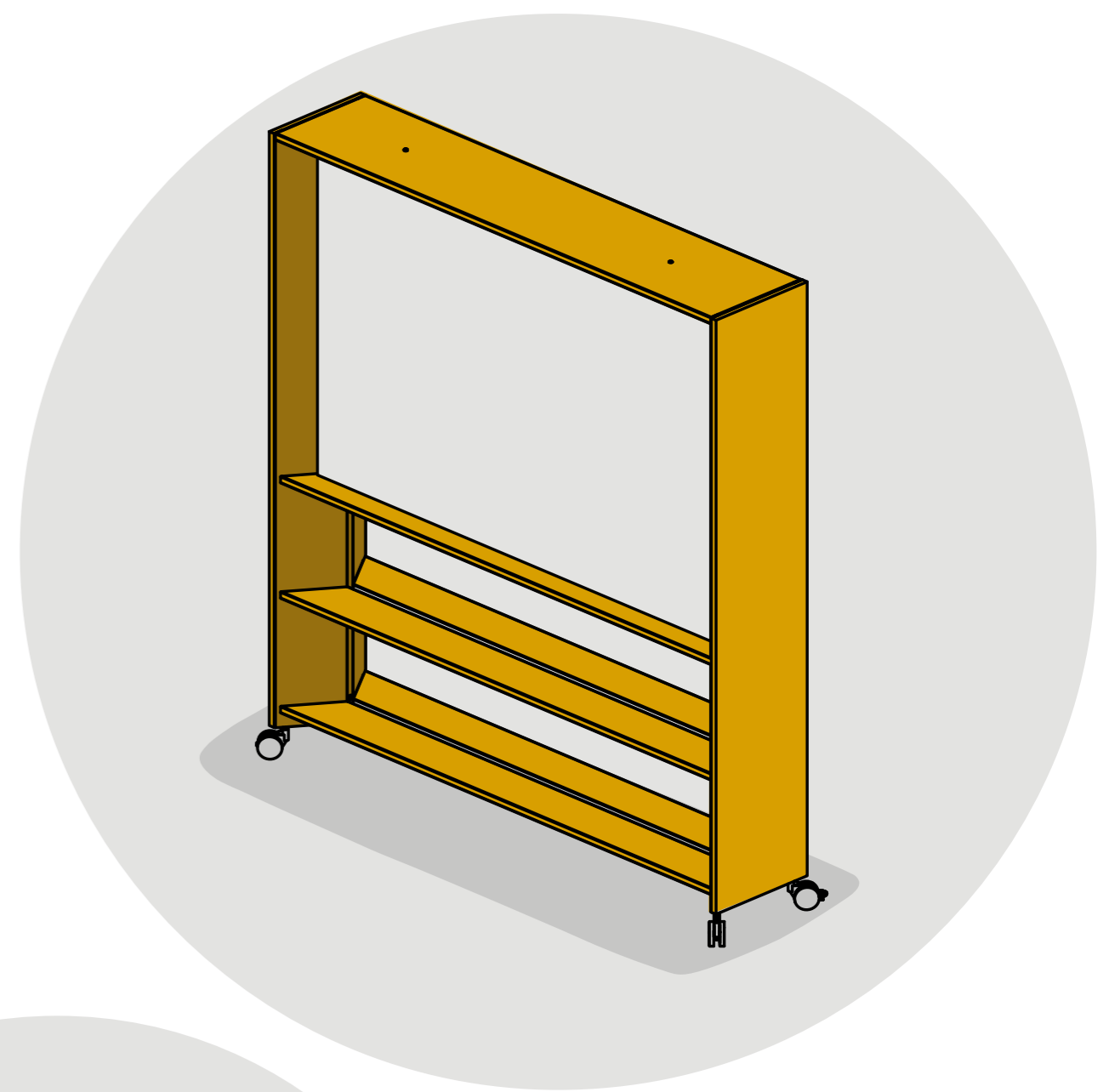

#workingspaces2024

# Gowall

01

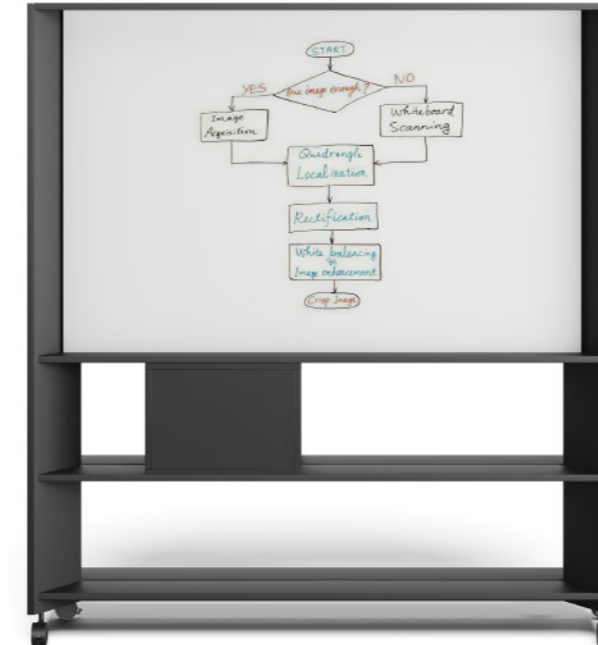

02

01  
Gowall Storage

02  
Gowall Board

## WORKING SPACES



#workingspaces2024

# Gowall

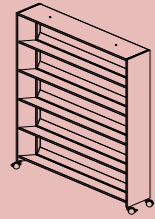

**Gowall**

Width 168  
Depth 34  
Height 184

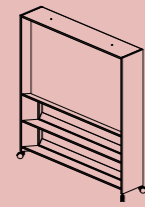

**Gowall TV**

Width 168  
Depth 34  
Height 184

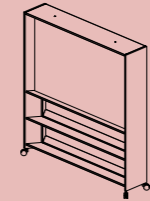

**Gowall White Board**

Width 168  
Depth 34  
Height 184

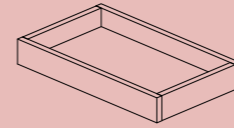

**Gowall\_ACP\_5030**

Width 50  
Depth 30  
Height 10

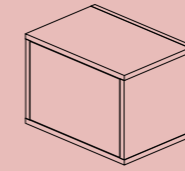

**Gowall\_BOX**

Width 45  
Depth 32  
Height 32

# Cliff

## WORKING SPACES

01

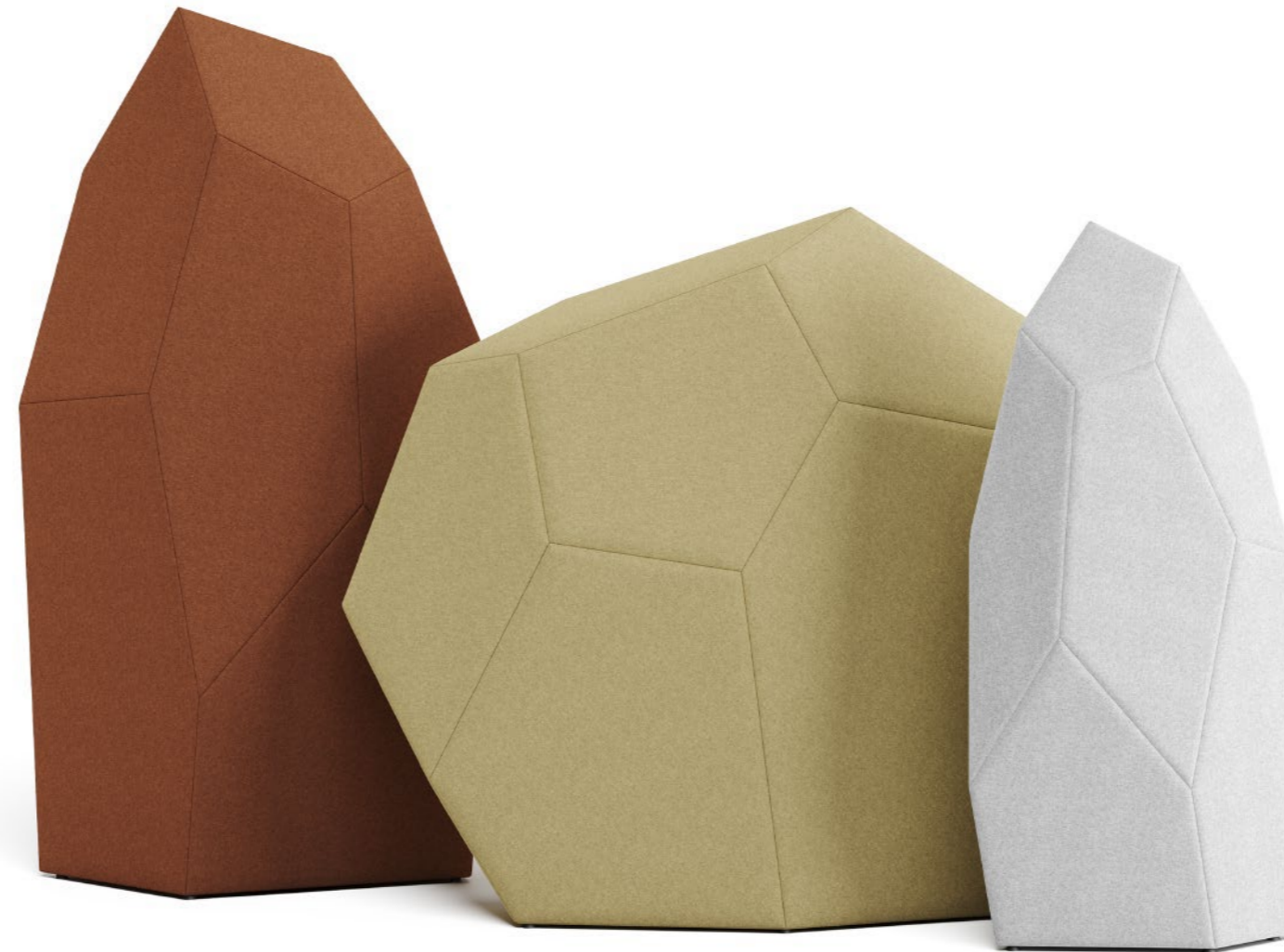
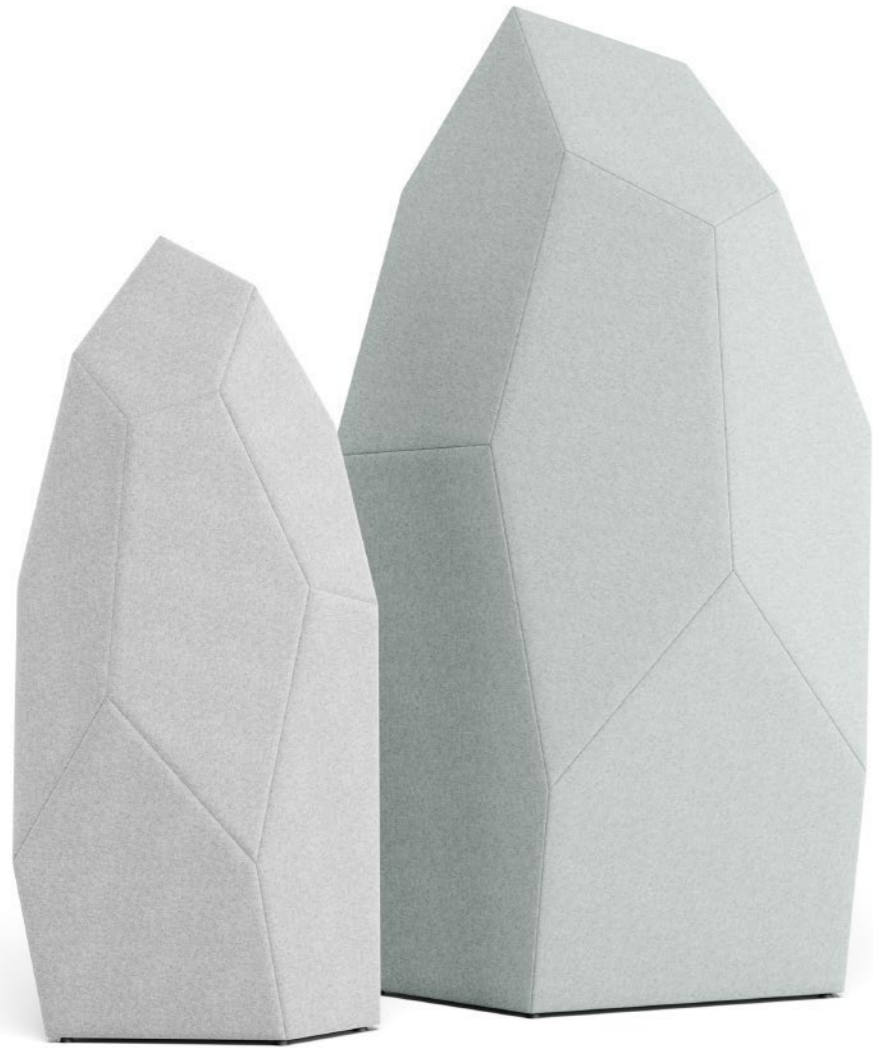

02

01  
Cliff Dividers

02  
Cliff Dividers



#workingspaces2024

# Cliff



## CLIFF\_SMALL

Width	98
Depth	42
Height	179

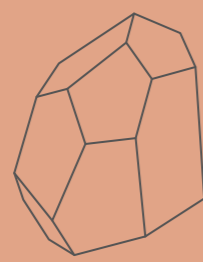

## CLIFF\_MIDDLE

Width	154
Depth	43
Height	140



## CLIFF\_HEIGHT

Width	65
Depth	46
Height	140